

CE 0682 ⓘ

KODEN

OPERATION MANUAL

MARINE RADAR

MDC-5200

SERIES

MDC-5500

SERIES

This product is specifically designed to be installed on boats and other means of maritime transport. If your country forms part to the EU, please contact your dealer for advice before attempting to install elsewhere.

MDC-5200/5500 Series Operation Manual**Doc No: 0093155002****Document Revision History**

No.	Doc. No.- Rev. No.	Date Revised (Y/M/D)	Revised Content
0	0093155002-00	2016/04/08	First edition
1			
2			
3			
4			
5			
6			
7			
8			
9			
10			

Document No. Revised Version Norm

When part of the document needs to be revised, the document has advanced revision number.

The document No. is indicated at the lower right side on the cover and at the left or right side of the footer region of each page.

© 2016 Kodens Electronics Co., Ltd. All rights reserved.

No part of this publication may be reproduced, transmitted, translated in any form by any means without the written permission of Kodens Electronics Co., Ltd. The technical descriptions contained in this publication are subject to change without notice. Kodens assumes no responsibility for any errors, incidentals or consequential damages caused by misinterpretation of the descriptions contained in this publication.





Important Notice

- For copy and transcription of this Operation Manual (hereinafter referred to as this manual), permission from Koden is needed. Koden prohibits the un-authorized copy and transcription of this manual.
- If this manual is lost or damaged, consult a dealer of Koden or Koden.
- The specification of the products and the contents in this manual are subject to change without notice.
- The contents displayed on the menu of product may be different from the expression of this manual. The fonts and shapes of the keys and menus in the illustration may differ from the actual ones, and some parts may be omitted.
- Koden is not liable for damages and troubles arisen from misunderstanding of the contents in this manual.
- Koden is not liable for any damages caused by earthquake, lightning, wind and flood damage and fire for which Koden is not responsible, and actions by third parties, other accidents, customer's unintended error/abuse and the use under other abnormal conditions.
- Koden is not liable for damages of accompaniment (change/loss of memorized content, loss of business profit, stop of business) arisen from use or failure of our products.
- If the stored data are changed or lost, irrespective of causes of troubles and damages, Koden is not liable for them.
- Koden is not liable for any damages arisen from malfunction caused by combination of software and connected equipment in which Koden is not engaged.





For Your Safe Operation

Symbols used in this Operation Manual

This manual uses the following symbols. Understand the meaning of each symbol and implement the maintenance and inspection.

Symbol	Meaning
 Warning	Warning Symbol This symbol denotes that there is a risk of death or serious injury when not dealt with it correctly.
	High Voltage Danger Symbol This symbol denotes that there is a risk of death or serious injury caused by electric shock when not dealt with it correctly.
 Caution	Caution Symbol This symbol denotes that there is a risk of slight injury or damage of device when not dealt with it correctly.
	Prohibition Symbol This symbol denotes restriction of the specified conduct. Description of the restriction is displayed near the mark.
IMPORTANT	Important Symbol This mark indicates important area where attention is needed. This may include possible data lose or other issues that may interfere with radar operation.
	Reference Symbol This mark shows the part to be referred to concerning this description.

Caution related to Equipment

	<p>Caution, high voltage inside. High voltage that may cause severe injury or death is present. High voltage remains in circuit even after power is turned off. High voltage circuit has a protective cover with a warning label. Make sure to turn off power and discharge capacitors before working on the system. Only authorized personnel should access this circuit for repair and maintenance.</p>
 <p>Warning</p>	<p>Confirm main power is turned off before servicing the equipment. If power switch is turned on while working on the system, possible severe injury or death may occur due to high voltage. Make sure main power is off and a label “Work In Progress” is attached to the breaker powering the system.</p>
 <p>Warning</p>	<p>Caution related to dust Inhaling dust may cause A respiratory disease. When cleaning the inside of equipment, be careful not to inhale dust. Wearing a safety mask is recommended.</p>
 <p>Caution</p>	<p>When choosing equipment location Do not install the equipment where it is excessively damp, humid and under direct dripping water.</p>
 <p>Caution</p>	<p>Caution related to static electricity Static electricity may be generated from floor carpet or synthetic clothes. Static may destroy some electronics parts of the circuit and therefore anti-static measures should be done.</p>

Caution related to Handling



Caution

Caution related to rotating aerial

The radar antenna may start rotating to rotate without notice. Please stand clear from the antenna for your safety.







Caution

Caution related to electromagnetic disturbance

The operating Antenna & Scanner unit radiates high-energy electromagnetic wave. It may cause harmful effect for human body due to its continuous radiation. As International regulation says, electromagnetic waves less than 100 watt/m² does not have a harmful effect on human bodies, but some kind of medical devices such as heart pacemakers are sensitive even under the low energy electromagnetic wave. Any personnel with such a device should keep away from the electromagnetic wave generating position at all times.

Specified power density and distance from the radar (in accordance with the provision as specified in IEC 60945)

Model name	Transmission power / Antenna length	100W/m ²	50W/m ²	10W/m ²
MDC-5204	4kW / 3 feet Antenna	0.9 m	1.3 m	2.8 m
MDC-5504	4kW / 4 feet Antenna	1.0 m	1.4 m	3.1 m
	4kW / 6 feet Antenna	1.2 m	1.7 m	3.7 m
MDC-5206	6kW / 4 feet Antenna	1.5m	2.1 m	4.5 m
MDC-5506	6kW / 6 feet Antenna	1.7 m	2.4 m	5.4 m
MDC-5212	12kW / 4 feet Antenna	2.1 m	2.9 m	6.4 m
MDC-5512	12kW / 6 feet Antenna	2.4 m	3.4 m	7.6 m
	12kW / 9 feet Antenna (MDC-5512 only)	2.9 m	4.1 m	9.0 m
MDC-5225	25kW / 4 feet Antenna	2.9 m	4.1 m	9.2 m
MDC-5525	25kW / 6 feet Antenna	3.5 m	4.9 m	10.9 m
	25kW / 9 feet Antenna (MDC-5525 only)	4.1 m	5.8 m	13.0 m

 Warning	<p>Do not disassemble or modify. It may lead to trouble, fire, smoking or electric shock. In case of trouble, contact our dealer or our company.</p>
 Warning	<p>In case of smoke or fire, switch off the power in the boat and the power of equipment. It may cause fire, electric shock or damage.</p>
	<p>Caution related to remaining high voltage. A high voltage may remain in the capacitor for several minutes after system is powered off. Before inspecting inside, wait at least 5 minutes after powering off or discharging the remaining electricity in an appropriate manner. Then, start the work.</p>
 Caution	<p>The information displayed in this unit is not provided directly for your navigation. For your navigation, be sure to see the specified material.</p>
 Caution	<p>Use properly rated fuse. If incorrect fuse is used, it may cause fire, smoke or damage.</p>

Break in procedure of stored radar**Caution**

Following procedure is recommended for “Break In” of the stored radar.

Otherwise the radar sometimes exhibits unstable transmitting operation such as arcing at its initial operation after long period of storage and make the operation more difficult.

1. Extend preheat time as long as possible (preferably 20 to 30 minutes).
2. Set the pulse width to the shortest one and start the operation.

When the operation in the shortest pulse is stable then go to operation in longer pulse and repeat the similar step until the operation reaches to the final pulse condition.

Used battery and radar disposal



Warning

A high-energy density lithium ion battery is installed in this radar. Improper disposal of a lithium ion battery is discouraged as the battery has a possibility of short-circuiting. If it gets wet, the generation of heat, explosion or ignition may occur resulting in an injury or fire.

Treatment of the used lithium ion battery

To dispose of built-in lithium ion battery (CR-2032) in this radar, insulate each terminal with tape, and wrap in plastic bag.

The disposal and collection rules may be different depending on each municipal district. Obey the directions of each district.

Disposal of this radar

This radar shall be disposed according to the municipal regulations or rules.

In case no Heading and Speed signals are input from navigation equipment

When no Heading and Speed signals are input from navigation equipment (in case not connected), this radar gives alarms and warning messages on the screen, if the radar is started up factory default settings.

These alarms are disengaged by pressing "OFF" key temporarily, however, the alarms are activated again next time the radar is start up.

Disengage the alarm detection function on start up by the following. Once set, the alarm is not detected next time the radar is started up.

MENU => [ALARM] => [ALARM ON/OFF] => [I/O] => [HDG INPUT] => [OFF], and press **ENT** key.

[ALARM] => [ALARM ON/OFF] => [I/O] => [SPD INPUT] => [OFF], and press **ENT** key.

[ALARM] => [ALARM ON/OFF] => [I/O] => [LAT/LON INPUT] => [OFF], and press **ENT** key.

Contents

Document Revision History.....	i
Important Notice.....	ii
For Your Safe Operation.....	iii
Break in procedure of stored radar.....	vii
Used battery and radar disposal.....	viii
In case no Heading and Speed signals are input from navigation equipment.....	ix
Contents.....	x
Introduction.....	xvii
Configuration items.....	xviii
System configuration.....	xviii
Option list.....	xx
Chapter 1 Display and Operation.....	1-1
1.1 Radar Display.....	1-1
Upper left corner.....	1-2
Upper right corner.....	1-2
Lower left corner.....	1-2
Lower right corner.....	1-2
ASSITANT INFO DISP.....	1-3
MAP INFO.....	1-4
1.2 Operation Unit.....	1-6
1.3 Menu usage.....	1-8
Turn MENU on and off.....	1-8
Select menu item.....	1-8
1.4 Cursor Access usage.....	1-10
Chapter 2 Radar Basic Operation.....	2-1
2.1 Power ON/OFF.....	2-1
Power ON.....	2-1
Power OFF.....	2-1
2.2 Change Brilliance.....	2-2
Display Brilliance.....	2-2
Panel Brilliance (Operation unit).....	2-3
2.3 Transmission.....	2-4
Transmission ON.....	2-4
Transmission OFF.....	2-4
2.4 Tuning method.....	2-5
Change MAN (manual) and AUTO.....	2-5

	Optimized value setup method.....	2-5
2.5	Change range scale.....	2-7
	Change range unit (NM / km / sm / kf / ky).....	2-7
2.6	Adjust receiver gain (GAIN).....	2-8
	Selection of MAN GAIN and AUTO GAIN	2-8
	AUTO adjustment of GAIN	2-8
	MAN adjustment of GAIN	2-9
2.7	Reject sea clutter (anti-SEA).....	2-10
	Selection of MAN SEA and AUTO SEA.....	2-10
	AUTO adjustment of SEA.....	2-11
	Manual adjustment of SEA.....	2-11
2.8	Reject rain/snow clutter (anti-RAIN)	2-12
	Changing method of CFAR and MAN	2-13
	CFAR (Constant False Alarm Rate) adjustment	2-13
	RAIN MAN (manual) adjustment	2-14
2.9	Change transmission pulse width (SP/LP)	2-15
2.10	Select Display Mode	2-16
	For H UP (Head up mode)	2-16
	For C UP (Course up mode)	2-17
	For N UP (North up mode)	2-17
	For relative motion (RM) and true motion (TM)	2-18
	Reset true motion.....	2-19
2.11	Ground and Sea stabilization.....	2-20
	SEA (Sea stabilization).....	2-20
2.12	Measurement of distance by RR and VRM	2-21
	Display Range Rings (RR)	2-21
	Measurement Range (VRM: Variable Range Marker).....	2-22
2.13	Measurement of bearing by EBL	2-23
	Using the EBL/VRM OFFSET	2-24
2.14	Bearing mode set up.....	2-25
2.15	Measurement of distance/bearing by PI	2-26
2.16	Measurement distance/bearing by ERBL	2-28
	Change ERBL mark to LINE or RING	2-30
2.17	Change color and brightness (Day/Night).....	2-31
	Setup color	2-31
	Setup USER1 and USER2 color	2-32
	Setup brightness	2-33
	Color and brightness settings reset.....	2-33
2.18	Remove the heading line / navigation data.....	2-34

2.19	Target trail.....	2-34
	Relative display (R).....	2-36
	True display (T).....	2-36
2.20	Off Center.....	2-37
2.21	Function key usage.....	2-38
2.22	Set picture mode.....	2-39
2.23	Echo process.....	2-40
	Correlation image echo process.....	2-40
2.24	Echo expansion.....	2-41
2.25	Interference rejection (IR).....	2-42
2.26	Video contrast.....	2-42
2.27	Noise rejection.....	2-43
2.28	Echo color rejection.....	2-43
2.29	Pulse width.....	2-44
2.30	Inter-switch.....	2-45
2.31	Cursor data.....	2-47
	CURSOR setting menu.....	2-47
2.32	Setup own ship outline.....	2-48
	Setup ship outline.....	2-48
2.33	FERRY MODE.....	2-49
2.34	Display setup.....	2-50
	2.34.1 ALL PPI mode.....	2-50
	2.34.2 ROTATION MARGIN (H UP, C UP).....	2-50
	2.34.3 ROTATION SPEED.....	2-51
	2.34.4 ASSISTANT INFO DISP.....	2-51
 Chapter 3 Alarm.....		 3-1
	Collision avoidance.....	3-1
3.1	Echo alarm.....	3-1
	How to set echo alarm area. (Fan type).....	3-1
3.2	Map area alarm.....	3-3
	How to edit map area.....	3-3
	How to move map area.....	3-4
	How to add data to map area.....	3-5
	How to delete the data of map area.....	3-6
	How to clear entire block of map area data.....	3-6
3.3	Guard zone alarm.....	3-7
	How to set guard zone alarm.....	3-7
3.4	Nav line cross.....	3-8

	How to edit	3-8
	How to move nav line	3-9
	How to add	3-10
	How to delete	3-11
	How to clear	3-11
3.5	Alarm on/off (TT and AIS)	3-12
Chapter 4	Target (AIS and TT)	4-1
4.1	Common setting	4-1
	VECTOR REL/TRUE	4-1
	CPA/TCPA alarm	4-3
	LOST ALARM	4-3
	Set AIS ID DISP TYPE	4-3
	Set TT ID DISP TYPE	4-4
	Set ID DISP SIZE	4-4
	Set Input range	4-4
	ASSOCIATION	4-5
	Automatic acquisition area	4-6
	PAST POSN: Past position	4-7
4.2	AIS	4-8
	Enable AIS function	4-8
	Select ID	4-8
	ACTIVE/SLEEP	4-8
	Ship outline	4-9
	HDG line	4-9
	Turn indicator	4-9
	OS display	4-9
	OS MMSI	4-9
	AIS filter	4-10
	AtoN ON/OFF	4-10
	AIS alarm [Sleeping lost]	4-11
	Types of AIS target symbol	4-12
4.3	TT (ARPA)	4-15
	Limitations of the TT function	4-15
	Enable TT function	4-16
	Manual acquisition	4-16
	Delete TT target	4-17
	Delete all TT targets	4-17
	Types of tracked target symbol	4-18

Chapter 5 Nav tool	5-1
5.1 Guard line.....	5-1
5.2 HL blink.....	5-2
5.3 Stern line	5-2
5.4 Barge icon	5-3
Chapter 6 Map operation	6-1
6.1 MAP function display ON or OFF	6-1
6.2 OWN SHIP PAST TRACK.....	6-1
How to Clear OWN SHIP PAST TRACK	6-2
6.3 Target track past position display	6-2
6.4 COAST LINE	6-3
How to edit.....	6-3
How to move.....	6-5
How to add.....	6-6
How to delete	6-7
How to clear.....	6-7
6.5 NAV LINE	6-8
6.6 ROUTE.....	6-9
6.7 EVENT MKR	6-10
6.8 AREA.....	6-11
6.9 MONITORED ROUTE.....	6-11
6.10 WPT ID DISP	6-12
6.11 TARGET TRACK ID	6-12
6.12 DATUM.....	6-13
6.13 EDIT USER DATUM.....	6-13
6.14 POSITION OFFSET	6-14
POSITION MANUAL OFFSET.....	6-14
6.15 WPT FLAG	6-14
6.16 LAT/LON LINE.....	6-14
6.17 C-MAP chart display.....	6-15
Chapter 7 System and Maintenance menu operation	7-1
7.1 SYSTEM MENU	7-1
7.2 Change UTC / LOCAL time.....	7-1
7.3 User memory.....	7-2
Change USER memory	7-2
How to save to memory	7-2
Edit User Name	7-2

	Default User setting.....	7-2
7.4	Sound setting	7-3
	Sound ON/OFF	7-3
	Sound frequency	7-3
	Key click ON/OFF	7-3
	External buzzer setting.....	7-3
7.5	LANGUAGE select.....	7-4
7.6	DISPLAY INFORMATION (DISP INFO)	7-4
7.7	UPPER DISP setting.....	7-5
7.8	HELP window ON/OFF	7-5
7.9	MAINTENANCE MENU	7-6
7.10	BACKUP of Setup data (Cannot be used while transmitting).....	7-6
	Internal save of setup data	7-6
	External save of setup and map data (Cannot be performed while transmitting)	7-7
	Parameter reset	7-8
	MAP/PAST reset	7-8
7.11	TOTAL HOUR and TX HOUR (Cannot be used while transmitting).....	7-9
7.12	MENU SETUP	7-9
7.13	System Program	7-10
	Version confirmation.....	7-10
	How to update the system program	7-11
Chapter 8 Principal of radar system		8-1
8.1	What is radar system?	8-1
	Side lobe	8-1
	Beam width	8-2
8.2	Characteristics of radar radio wave	8-2
	Target hardness reflected.....	8-2
	Radar shadow	8-3
	False image.....	8-3
8.3	Radar interference	8-5
Chapter 9 Simple fault diagnosis.....		9-1
9.1	No alarm sound.....	9-2
9.2	Operation unit (panel) key is not operational	9-3
9.3	TT is not operational	9-4
9.4	No AIS display.....	9-5
9.5	Need to confirm serial input	9-6

9.6	No radar video display	9-7
Chapter 10	Specifications	10-1
10.1	Antenna and Scanner unit.....	10-1
10.2	Display and Operation unit.....	10-2
10.3	External view and dimensions.....	10-3
Chapter 11	Appendix.....	11-1
11.1	Menu tree	11-1
Chapter 12	Index	12-1

Introduction

The MDC-5204/5206/5212/5225 type Radar system is a compact and high performance shipboard radar system consisting of the antenna & scanner unit with a transmit power of 4kW/6kW/12kW/25kW and display unit with 12.1 inch color LCD display.

The MDC-5504/5506/5512/5525 type Radar system is the system which consists of the antenna & scanner unit with the transmit power 6kW/12kW/25kW, a display unit with a 15 inch color LCD display and operation unit.

For this radar, its multi functions and high performance are accomplished with microcomputer technology as well as an image processing in the newly developed radar-dedicated LSI (Large Scale Integration).

- A slim Display unit using liquid crystal technology.
- Stable indication and reliable acquisition of small targets.
- Clear distinction between a moving target and land by true trail display.
- Provision of multi targets TT (ARPA), AIS information and chart display.
- Various models for selection of optimum radar for your needs.
- Simple and easy operation by user-friendly rotating knobs.
- Capable of adjusting gain, anti- sea clutter, anti- rain clutter, bearing cursor, and range marker, etc. using rotating knobs.
- The waterproof (IPX5) display and operation unit (IP23) has a great flexibility in installation.

Configuration items

System configuration

MDC-5204

No.	Name	Type
1	Antenna	*
2	Scanner	RB806
3	Display unit	MRD-111
4	Connecting cable	242J159098B-15M
5	DC power cable	CW-259-2M
6	Spare parts	SP-MRD-109_111
7	Installation material	M12-BOLT.KIT
8	Installation material	CONNECTOR.KIT
9	Operation manual	MDC-5200_5500.SER.OM.E
10	Installation manual	MDC-5200_5500.SER.IM.E
11	Quick reference	MDC-5200_5500.SER.QR.E

* RW701A-03: 3 feet, RW701A-04: 4feet, RW701A-06: 6feet

MDC-5206/5212/5225

No.	Name	Type
1	Antenna	*
2	Scanner	**
3	Display unit	MRD-111
4	Connecting cable	CW-845-15M
5	DC power cable	CW-259-2M
6	Spare parts	SP-MRD-109_111
7	Installation material	M12-BOLT.KIT
8	Installation material	CONNECTOR.KIT
9	Operation manual	MDC-5200_5500.SER.OM.E
10	Installation manual	MDC-5200_5500.SER.IM.E
11	Quick reference	MDC-5200_5500.SER.QR.E

* RW701A-04: 4feet, RW701A-06: 6feet

** RB807: 6kW (MDC-5206), RB808: 12kW (MDC-5212), RB809: 25kW (MDC-5225)

MDC-5504

No.	Name	Type
1	Antenna	*
2	Scanner	RB806
3	Display unit	MRD-109
4	Operation unit with connecting cable	MRO-108
5	Connecting cable	242J159098B-15M
6	DC power cable	CW-259-2M
7	Spare parts	SP-MRD-109_111
8	Installation material	M12-BOLT.KIT
9	Installation material	CONNECTOR.KIT
10	Operation manual	MDC-5200_5500.SER.OM.E
11	Installation manual	MDC-5200_5500.SER.IM.E
12	Quick reference	MDC-5200_5500.SER.QR.E

* RW701A-03: 3 feet, RW701A-04: 4feet, RW701A-06: 6feet

MDC-5506/5512/5525

No.	Name	Type
1	Antenna	*
2	Scanner	**
3	Display unit	MRD-109
4	Operation unit with connecting cable	MRO-108
5	Connecting cable	CW-845-15M
6	DC power cable	CW-259-2M
7	Spare parts	SP-MRD-109_111
8	Installation material	M12-BOLT.KIT
9	Installation material	CONNECTOR.KIT
10	Operation manual	MDC-5200_5500.SER.OM.E
11	Installation manual	MDC-5200_5500.SER.IM.E
12	Quick reference	MDC-5200_5500.SER.QR.E

* RW701A-04: 4feet, RW701A-06: 6feet, RW701B-09: 9feet (MDC-5512/MDC-5525)

** RB807: 6kW (MDC-5506), RB808: 12kW (MDC-5512), RB809: 25kW (MDC-5525)

Option list

No.	Name	Type	Comment
1	Gyro Interface	S2N, U/N 9028C	Gyro converter
2	Log pulse NMEA converter	L1N, U/N 9181A	200pulse/NM only
3	Gyro / Log interface	ADPC-101	
4	Rectifier unit	PS-010	5A fuse attached
		VL-PSG001	20A fuse attached
5	AC power cable	VV-2D8-3M	Without a connector on the both sides
6	Junction box	JB-35	With CW-376-5M
7	Connecting cable	CW-373-*	With 6-pin water resistant connectors at both ends (cable for data)
		*: 5M, 10M or 30M	
		CW-374-5M	With a 6-pin connector and a 6-pin water resistant connector (cable for data)
		CW-376-5M	With a 6-pin water resistant connector and one end plain (cable for data)
		CW-387-5M	With a 8-pin water resistant connector and one end plain (cable for AIS)
		CW-561-*	With 12-pin water resistant connectors at both ends (connector for remote display)
		*: 10M or 30M	
		CW-576-0.5M	With a 10-pin water resistant connector and D-Sub connector (analog RGB) +Alarm out
CW-560-2M	With 15-pin water resistant D-Sub connectors at both ends (Cable for VDR or external Display unit to connect CW-576-0.5M)		
CW-401- *	Operation unit (MRO-108) cable		
*: 5M or 10M			
8	Antenna unit – Display unit connecting cable	242J159098C-20M	With a connector on the both sides
		242J159098D-30M	
		242J159098*-**M	
		**: 100 m max	Note: For MDC-5204/5504
		CW-845-*	With a connector on the both sides
*: 20M, 30M, 50M, 65M			
CW-845-**M			
**: 100 m max	Note: For MDC-5206/5212/5225/5506/5512/5525		

Chapter 1 Display and Operation

1.1 Radar Display

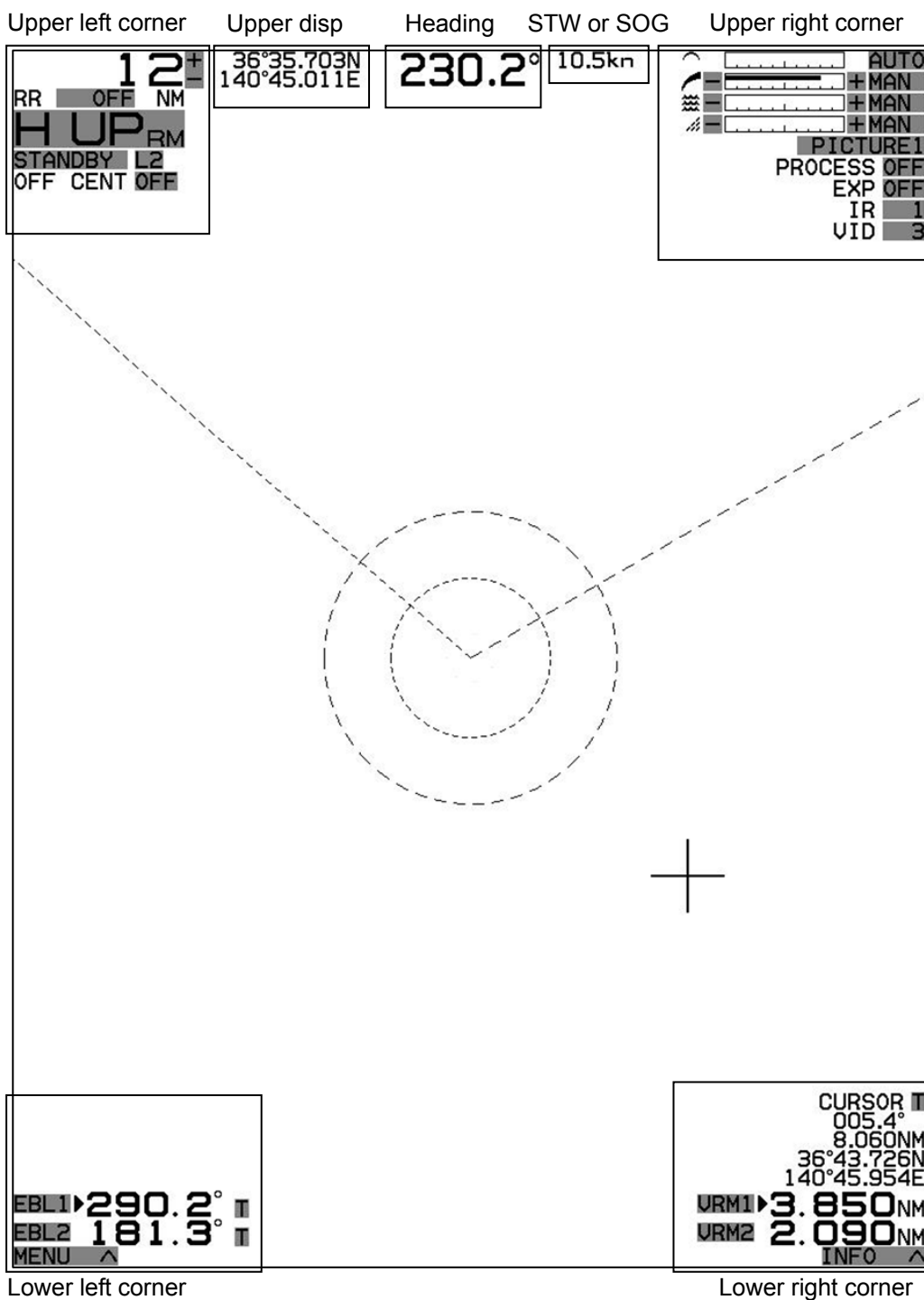

Upper left corner

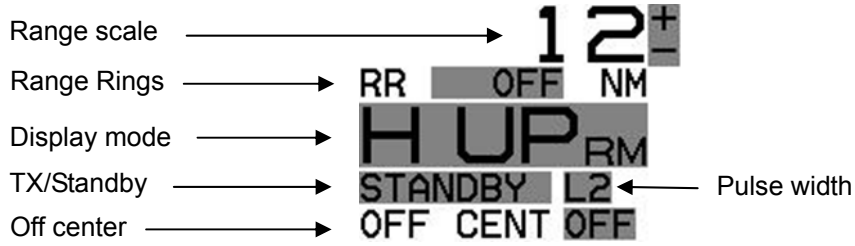

Upper right corner

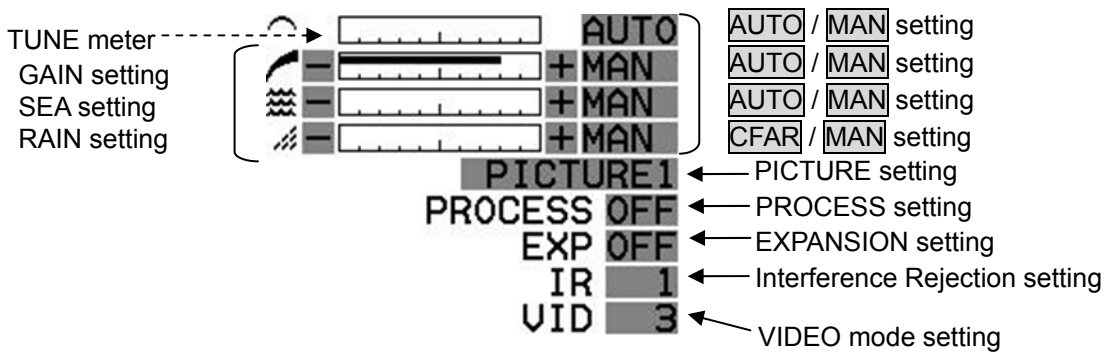

Lower left corner

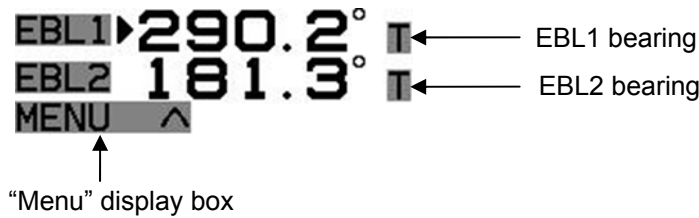

Lower right corner

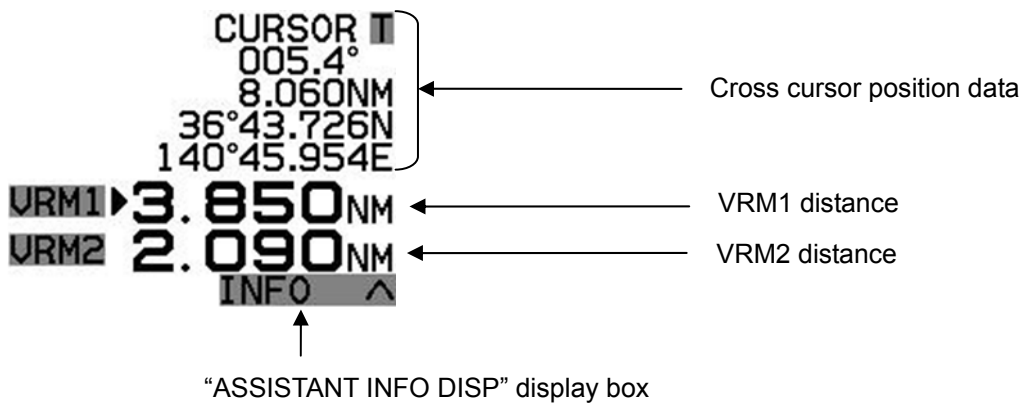

ASSITANT INFO DISP

Move cursor on the **INFO△** box at lower right corner of the display, and press **ENT** key.

Three "ASSISTANT INFO DISP" windows appear, and various navigation data will be shown.

Move cursor on the **INFO▽** box at upper right corner of the "ASSISTANT INFO DISP" window, and press **ENT** key. All "ASSISTANT INFO DISP" windows disappear.



OWN SHIP INFO

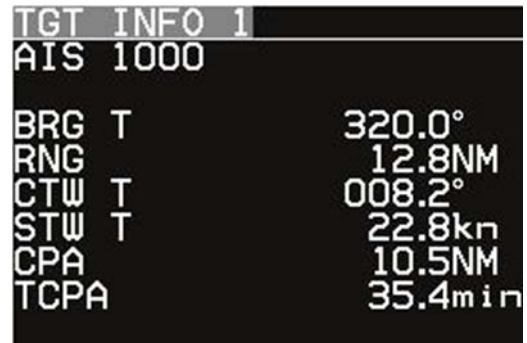

TGT INFO (AIS)

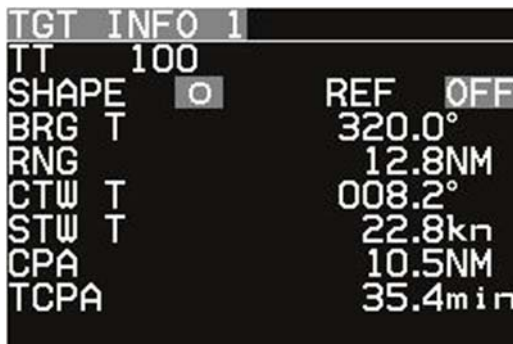

TGT INFO (TT)

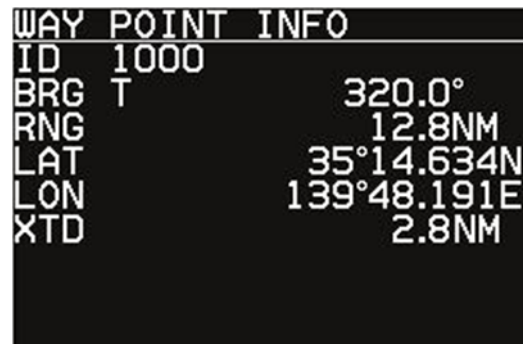

WAY POINT INFO

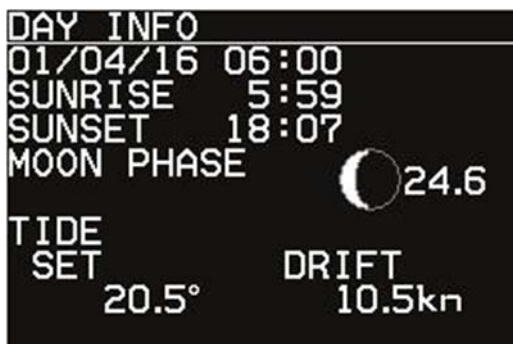

DAY INFO

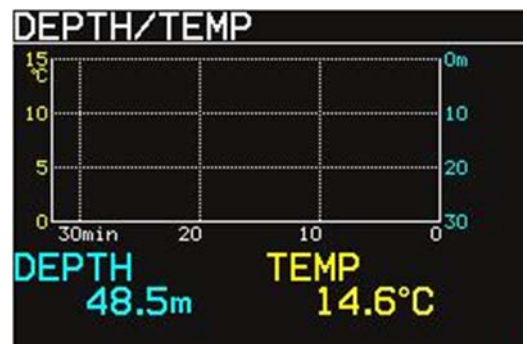

DEPTH / TEMP

In addition, "WIND, CRS/SPD or SET/DRIFT" window can be displayed.

Refer to 2.34.4 ASSISTANT INFO DISP.

MAP INFO

During Map data (*1) edit, "MAP INFO" window is displayed at lower of the display.

<Example of EVENT MKR INFO>

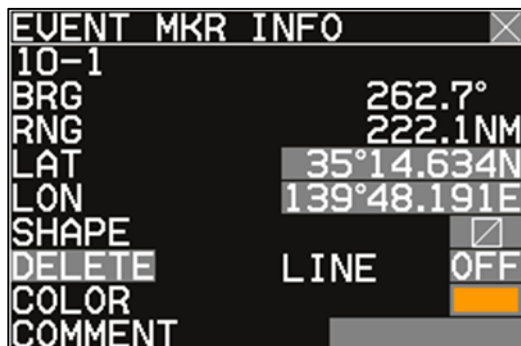

(*1) COAST LINE, NAV LINE, ROUTE, EVENT MKR and AREA

Refer to Chapter 6 Map operation.

- This page intentionally left blank.-

1.2 Operation Unit

MDC-5200 series

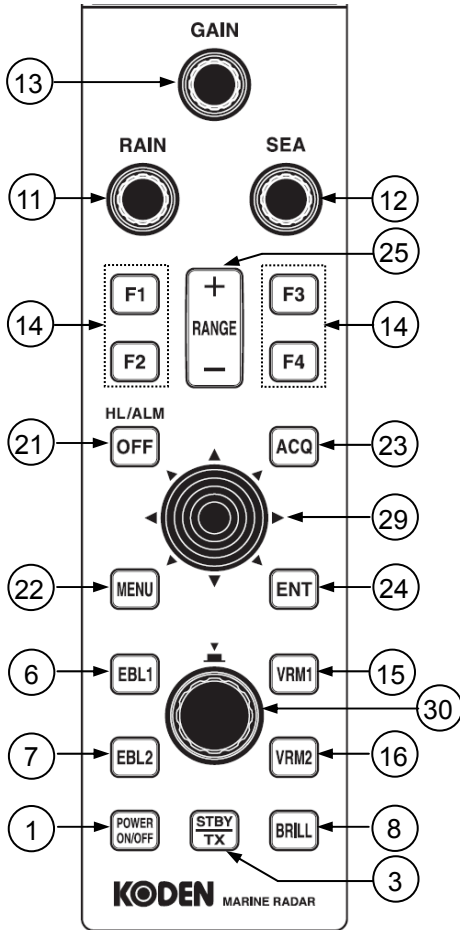

1	POWER ON/OFF key
2	POWER lamp
3	STBY/TX key
4	SP/LP key
5	DAY/NIGHT key
6, 7	EBL1, EBL2 key
8	BRILL key
9	EBL/BRILL knob
10	OFFSET lamp
11	RAIN knob
12	SEA knob
13	GAIN knob
14	FUNCTION keys
15, 16	VRM1, VRM2 key
17	PANEL key
18	VRM/PANEL knob
19	PI lamp
20	ERBL key
21	OFF key
22	MENU key
23	ACQ key
24	ENT key
25	RANGE key
26	MODE key
27	OFF CENT key
28	TRACKBALL
29	JOYSTICK
30	EBL/VRM knob

MDC-5500 series

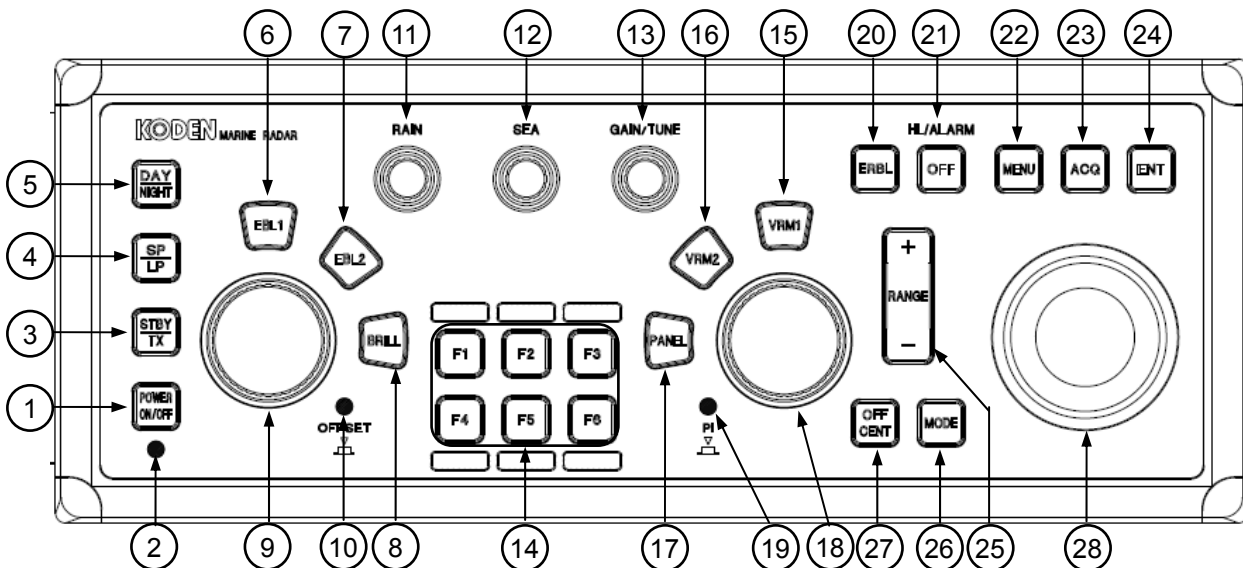

- | | | |
|---|------------------------------------|--|
| ① | POWER ON/OFF key | Turn on and off the power. |
| ② | POWER lamp | Status of power on. (MDC-5500 series only) |
| ③ | STBY/TX key | Transmission on and off. |
| ④ | SP/LP key | Change transmission on and off. (MDC-5500 series only) |
| ⑤ | DAY/NIGHT key | Change echo color, day or night. (MDC-5500 series only) |
| ⑥ | EBL1 key | EBL1 on and off. |
| ⑦ | EBL2 key | EBL2 on and off. |
| ⑧ | BRILL key | Control window of display brilliance on or off. (MDC-5500 series)
Control window of display and panel brilliance on or off. (MDC-5200 series) |
| ⑨ | EBL/BRILL knob | Adjust EBL1, EBL2 or display brilliance. |
| ⑩ | OFFSET lamp | Status lamp of offset EBL mode on. (MDC-5500 series only) |
| ⑪ | RAIN knob | Reduce rain clutter. |
| ⑫ | SEA knob | Reduce sea clutter. |
| ⑬ | GAIN knob | Adjust radar receiver gain. |
| ⑭ | Function key F1 – F4 | Quick short cut menu access. (MDC-5200 series) |
| | Function key F1 – F6 | Quick short cut menu access. (MDC-5500 series) |
| ⑮ | VRM1 key | VRM1 on or off. |
| ⑯ | VRM2 key | VRM2 on or off. |
| ⑰ | PANEL key | Control window of panel brilliance on or off. (MDC-5500 series only) |
| ⑱ | VRM/PANEL knob | Adjust VRM1, VRM2 or panel brilliance. |
| ⑲ | PI lamp | Status lamp of parallel index lines on. (MDC-5500 series only) |
| ⑳ | ERBL key | Electronic range and bearing line on and off. (MDC-5500 series only) |
| ㉑ | OFF key | Erase heading line, stop alarm sound, etc. |
| ㉒ | MENU key | Turn MENU on and off. |
| ㉓ | ACQ key | Start manual TT acquisition. |
| ㉔ | ENT key | Key most often used to make a selection. |
| ㉕ | RANGE key | Change radar range scale. |
| ㉖ | MODE key | Change display mode HU/NU/CU. (MDC-5500 series only) |
| ㉗ | OFF CENT key | Off center mode on and off. (MDC-5500 series only) |
| ㉘ | TRACKBALL | Used to make MENU selection and move cursor. (MDC-5500 series only) |
| ㉙ | JOYSTICK | Used to make MENU selection and move cursor. (MDC-5200 series only) |
| ㉚ | EBL/VRM knob | Adjust EBL1, EBL2, VRM1, VRM2 etc. (MDC-5200 series only) |

1.3 Menu usage

Turn MENU on and off

- 1 Press **MENU** key then Main menu is displayed on the lower left of the display.
- 2 “Menu” display is turned off by pressing **MENU** key again.

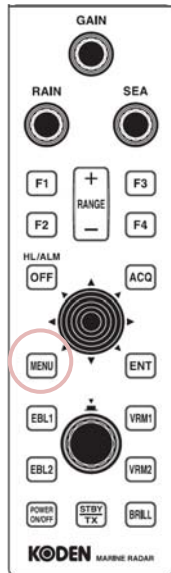

MDC-5200 series

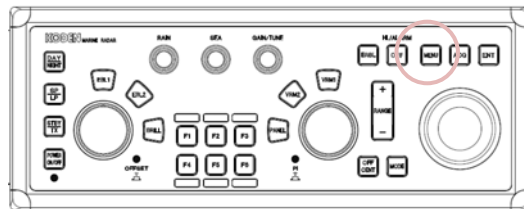

MDC-5500 series

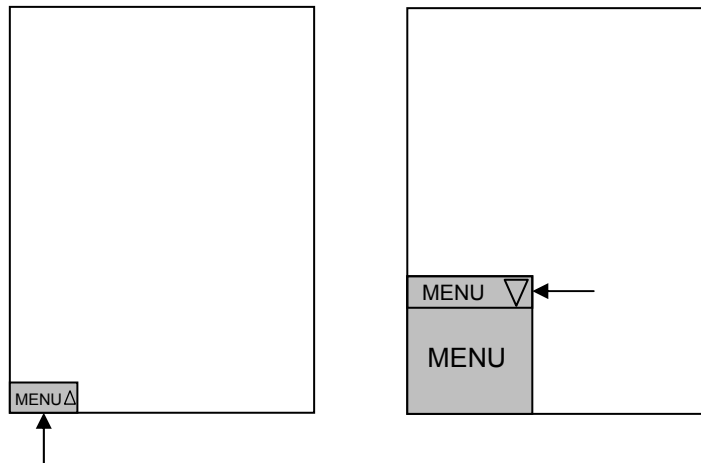

Note: Move cursor on the **MENU ▲** box at lower left corner of the display, and press **ENT** key.

Similarly, “Menu” is displayed.

Move cursor on the **MENU ▼** box at the top of the menu display, and press **ENT** key.

“Menu” display is turned off.

Select menu item

- 1 Press **MENU** key and “Main menu” will show on the display. Select one of main menu items by moving the trackball/joystick up or down.
- 2 Move the trackball/joystick to the right after making selection in main menu and the sub menu will show on the display.
- 3 Select a sub menu item by moving the trackball/joystick up or down.
- 4 Move the trackball/joystick to the right after making selection in sub menu and value of selected item will show.
- 5 Select desired value then press **ENT** key.
Note: Pay attention that **ENT** key must be pressed for selected item to take effect.
- 6 Move trackball/joystick to the left to return to previous menu.
To exit from menu, press **MENU** key again.

<Example of menu display>

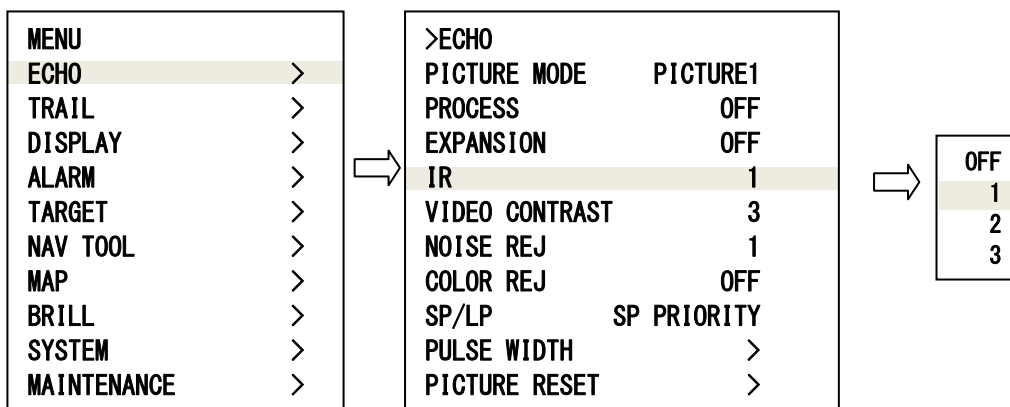

Note: "Menu" setup value is stored in the non-volatile memory inside the radar. Therefore, no setup operation is required after power is turned on.

Note: About the shaded menu:

[INTER-SWITCH] in [SYSTEM] menu, and [SECTOR MUTE], [BACKUP], [TOTAL HOUR] and [TX HOUR] in [MAINTENANCE] menu are not available during transmission, therefore they are greyed out.



1.4 Cursor Access usage

Basic radar functions can be operated by using the trackball/joystick and **ENT** key without using menu. Move cursor on a grey item with trackball/joystick, then press **ENT** key.

This function is effective at the time of the operation with the USB mouse or trackball from the remote place.

Example: Upper left corner

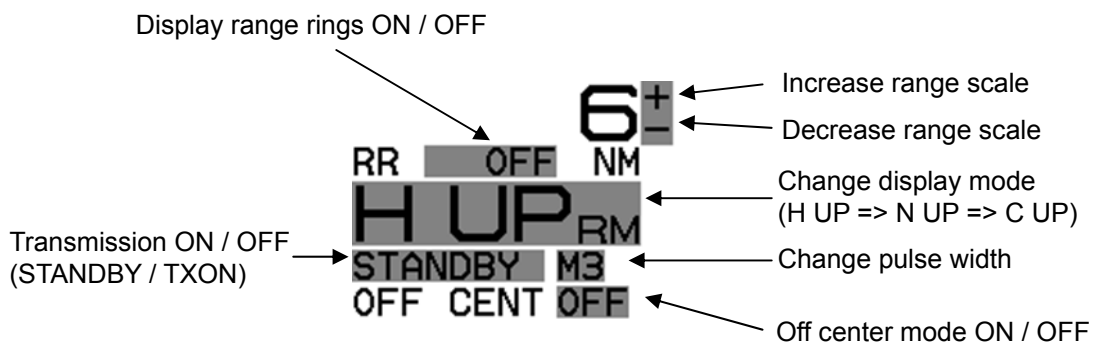

Chapter 2 Radar Basic Operation

2.1 Power ON/OFF

Power ON

Press **POWER ON/OFF** key located at the lower left corner of the operating unit. Radar system is turned on with beep sound.

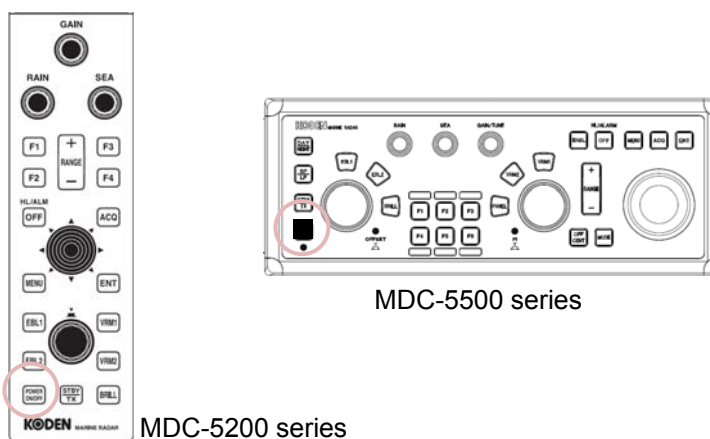

After power on, radar model name and preheating countdown time will appear at the center of the display.

Wait for 120 sec. (*1) or 180 sec. (*2) until preheating countdown time has disappeared, and status changes from **WAIT** to **STANDBY** at the upper left of the display.

(*1) MDC-5204/5206/5212/5504/5506/5512

(*2) MDC-5025/5525

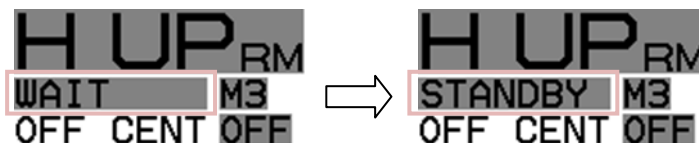

The brilliance of the display is set to the previous value of the last power off.

During operation, "POWER LAMP" under **POWER ON/OFF** key lights up red. (MDC-5500 series only)

Note: The power source shall not be turned off until operational window is displayed.

Power OFF

Press **POWER ON/OFF** key for two sec. for power off.

"SHUTDOWN" message appears at the center of the display,

release **POWER ON/OFF** key immediately, and from five to ten sec. later will completely power off.

Note:

- The power source shall be turned off by pressing **POWER ON/OFF** key.
When the ship's power source is lost during operation, an important setup data may be lost.
- After radar has been turned off, wait at least five seconds before turning it back on.

2.2 Change Brilliance

Display Brilliance

(For MDC-5200 series)

- 1 Press **BRILL** key.

Note: Each time **BRILL** key is pressed, it changes over “Display brilliance” and “Panel brilliance”.

- 2 The BRILL adjustment window will appear in the upper left of the display.

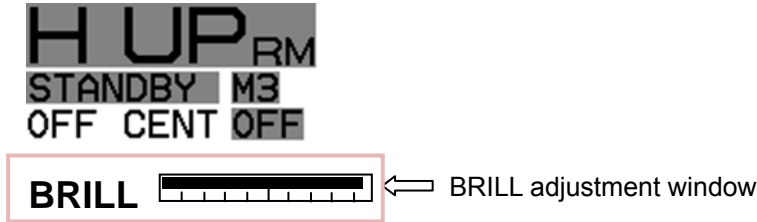

- 3 Turn **EBL / VRM** knob clockwise to increase the display brilliance.

Turn **EBL / VRM** knob counter clockwise to decrease the display brilliance.

The display brilliance can also be changed in five steps by pressing **EBL / VRM** knob.

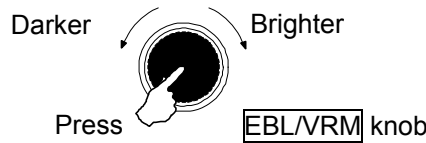

(For MDC-5500 series)

- 1 Press **BRILL** key.

- 2 The BRILL adjustment window will appear in the upper left of the display.



- 3 Turn **EBL** knob clockwise to increase the display brilliance.

Turn **EBL** knob counter clockwise to decrease the display brilliance.

The display brilliance can also be changed in five steps by pressing **EBL** knob.

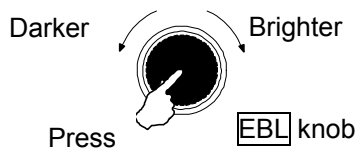

Panel Brilliance (Operation unit)

(For MDC-5200 series)

- 1 Press **BRILL** key twice.
Note: Press once during display brilliance window is displayed.
- 2 The PANEL adjustment window will appear in the upper left of the display.

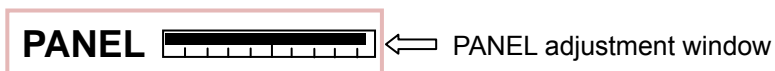

- 3 Turn **EBL / VRM** knob clockwise to increase the lighting of the panel brilliance.
Turn **EBL / VRM** knob counter clockwise to decrease the lighting of the panel brilliance.
The panel brilliance can also be changed in five steps by pressing **EBL / VRM** knob.

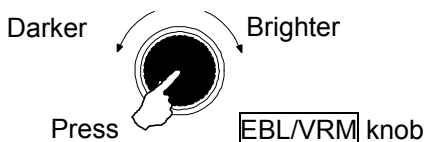

(For MDC-5500 series)

- 1 Press **PANEL** key.
- 2 The PANEL adjustment window will appear in the upper left of the display.

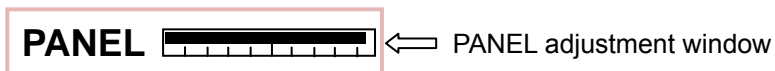

- 3 Turn **VRM** knob clockwise to increase the lighting of the panel brilliance.
Turn **VRM** knob counter clockwise to decrease the lighting of the panel brilliance.
The panel brilliance can also be changed in five steps by pressing **VRM** knob.

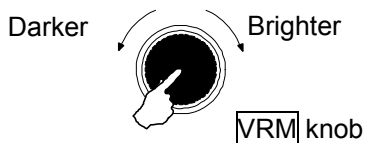

2.3 Transmission

Transmission ON

After preheating time countdown is completed, the radar can be placed in transmit mode.

Press **STBY/TX** key, or select the **STANDBY** box at the upper left corner of the display using trackball/ joystick, and press **ENT** key.

Radar system will start transmission.

The status of **STANDBY** changes to **TRANSMIT**.

By **STBY/TX** key

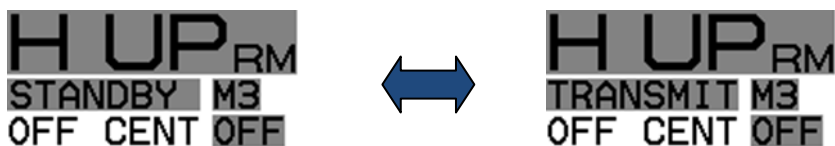

By trackball/Joystick

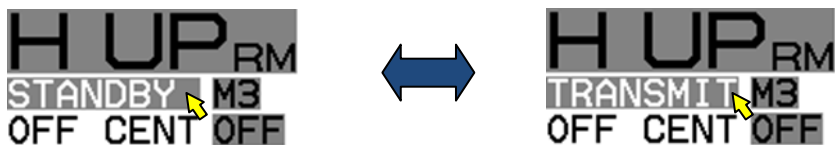

Transmission OFF

Press **STBY/TX** key, or select the **TRANSMIT** box at the upper left corner of the display using trackball/joystick and press **ENT** key to stop transmission.

The status of **TRANSMIT** returns to **STANDBY** at upper left of the display.

2.4 Tuning method

The transmitting and receiving frequency of this radar may become detuned by environmental changes.

This result in “detuning” of the gain and the same echo images may show weaker, even if the setup is the same as before.

Tuning method can be changed directly in the upper right of the display, with trackball/joystick and press **ENT** key, without using menu function.

Tuning menu operation method, refer to 4.1.1 Tune adjustment of Installation manual.

Change MAN (manual) and AUTO

By CURSOR

Move CURSOR to the **MAN** or **AUTO** box (whichever is shown) of tune indicator at upper right of the display using trackball/joystick, and press **ENT** key.

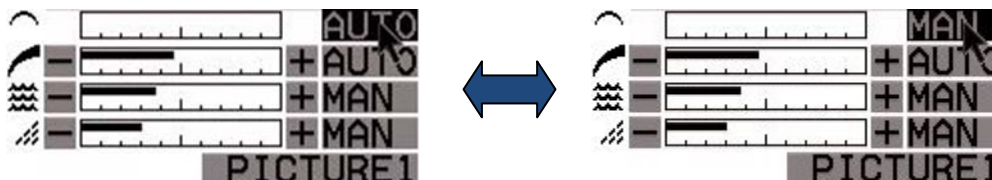

By MENU

- 1 Press **MENU** key to display “Menu”.
Select [MAINTENANCE] => [STARTUP] => [TUNE] => [TUNE] => select [MAN] or [AUTO], and press **ENT** key.

Optimized value setup method

Adjustment shall be performed based on stable echo object such as from land. (Land is used in following explanation.)

- 1 Set RAIN and SEA at 0.
- 2 Set lower GAIN until land echo almost disappears.
- 3 Press **MENU** key to display “Menu”.
Select [MAINTENANCE] => [STARTUP] => [TUNE] => [AUTO ADJ] or [MAN ADJ] will show the current setting of the input value by highlighting the last digit value by the trackball/joystick.
- 4 Move the trackball/joystick up or down to change the value, and obtain the maximum magnitude of the target on the display. When a target becomes too strong to find the peak, lower gain with **GAIN** knob once again and adjust the tune to obtain the maximum magnitude of target.

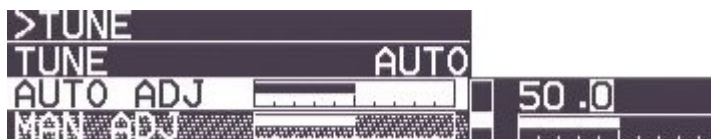

- 5 Press **ENT** key to save the result or the maximum magnitude of target.

By **GAIN/TUNE** knob (MDC-5500 series only)

- 1 Press **GAIN/TUNE** knob until light around knob turns red.
Tune value box will appear on the place of **MAN** or **AUTO** box of tune indicator.

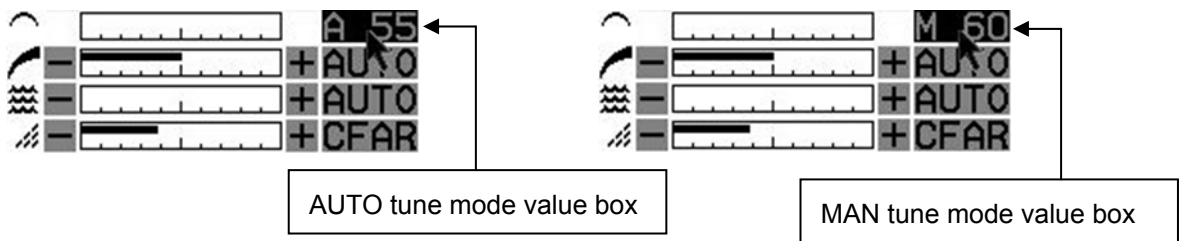

- 2 Turn **GAIN/TUNE** knob clockwise or counter clockwise to get the strongest land echo.
- 3 When tune adjustment is completed, press **GAIN/TUNE** knob or **ENT** key to save setting data to internal memory.
Light around **GAIN/TUNE** knob will turn green.
- 4 Repeat step 1 to 3 for both **MAN** and **AUTO** modes.

2.5 Change range scale

The coverage area can be changed by changing range scale.

Larger the value of range the more coverage area expands. (The target image will become smaller.)

The range scale value and range rings value are indicated at the upper left on the display.

Range scale can be changed directly at the upper left of the display, with trackball/joystick and **[ENT]** key, without using **[RANGE+]** and **[RANGE-]** key.

- 1 Press **[Range +]** key to zoom out the picture, and to observe a wider area.
Press **[Range -]** key to zoom in the picture, to magnify and to observe closer to Antenna position.

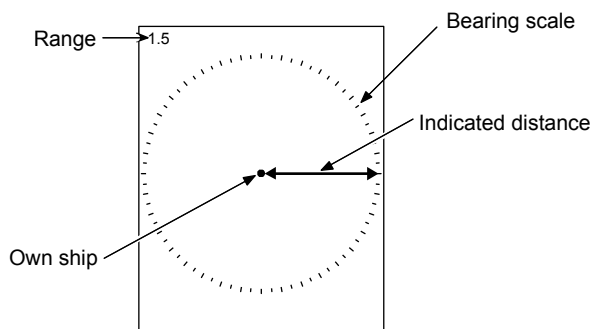

Model-specific ranges are as shown below. (Standard setting)

Model name	MDC-5225 / 5525 (Max. output: 25 kW)												
	MDC-5212 / 5512 (Max. output: 12 kW)												
	MDC-5206 / 5506 (Max. output: 6 kW)												
	MDC-5204 / 5504 (Max. output: 4 kW)												
Range(NM)	0.125	0.25	0.5	0.75	1.5	3	6	12	24	32	48	64	96

Change range unit (NM / km / sm / kf / ky)

The unit of range measurement can use five kinds of distance units.

- Selection unit: NM: nautical mile
 km: kilo meter
 sm: statute mile
 kf: kilo foot
 ky: kilo yard

- 1 Press **[MENU]** key to display "Menu".
Select **[DISPLAY] => [RANGE UNIT] =>** Select **[NM]**, **[km]**, **[sm]**, **[kf]** or **[ky]**, and press **[ENT]** key.

When changing to other range unit, Range and Cursor range unit will be changed.

2.6 Adjust receiver gain (GAIN)



It is recommended to adjust [GAIN] in the upper right side of the display to have the evenly scattered vague background noise with low intensity in the PPI.

Lower than required [GAIN] may result in missing small vessels and buoys.

Higher [GAIN] than required may result in difficult discrimination between small ships and densely displayed high level background noise.

Under some situation, desired target object may be masked by side lobe of antenna directivity or false echo by multi path.

Lower [GAIN] until masked target echo can be recognized outside of the area where 2.7 “Reject sea clutter (**anti-SEA**)” is effective.

However since lower [GAIN] tends to lose weak target echo, try to return the [GAIN] to original position each time [GAIN] is changed to maintain target recognition. In the short distance area where anti-SEA is effective, recognize target by adjusting MAN SEA.

When suppressing RAIN clutter (rain & snow), adjust **[GAIN]** knob and **[RAIN]** knob side by side.

[GAIN] state is displaying in the upper right of the display.

Selection of MAN GAIN and AUTO GAIN

By **[GAIN]** knob

When the **[GAIN]** knob is pressed, **[AUTO GAIN]** and **[MAN GAIN]** change alternately.

By trackball/joystick

- 1 Move cursor on the **[MAN]** or **[AUTO]** display (whichever is shown) at right side of [GAIN] on the top of the display.
- 2 Press **[ENT]** key to change **[AUTO]** or **[MAN]** as appropriate.

AUTO adjustment of GAIN

When **[AUTO GAIN]** is set, [GAIN] is adjusted automatically.

Note: AUTO GAIN may remove weak target echoes, or too much sea clutter may be on the display, turn **[GAIN]** knob clockwise or counterclockwise to adjust AUTO GAIN effectively.

If not setup properly, adjust AUTO GAIN settings by referring to 4.4.3 Setup GAIN MIN and MAX mode of Installation manual.

MAN adjustment of GAIN

When **MAN GAIN** is selected, GAIN can be adjusted manually.

- 1 Turn **GAIN** knob clockwise to increase receiving gain.
Turn **GAIN** knob counterclockwise to decrease receiving gain.



Note:

- Decrease gain for shorter range and dense targets.
- Increase gain for long range targets and small target however take care in not using too much gain and losing targets in the surrounding noise.

Result picture after adjustment by gain knob

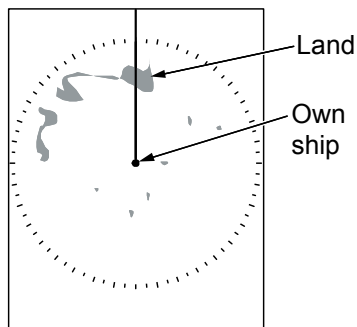

< Picture of too low gain >

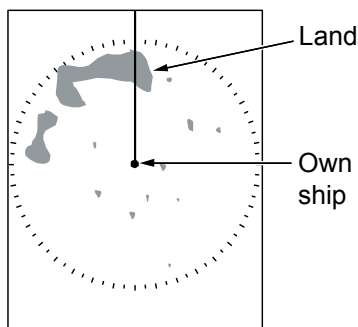

< Picture of moderate gain >

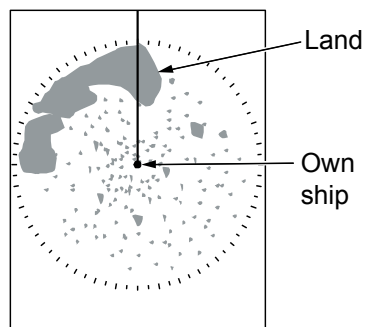

< Picture of too high gain >

2.7 Reject sea clutter (anti-SEA)

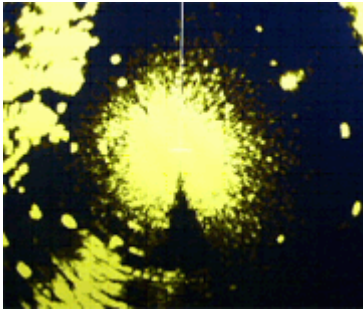

SEA clutter at center

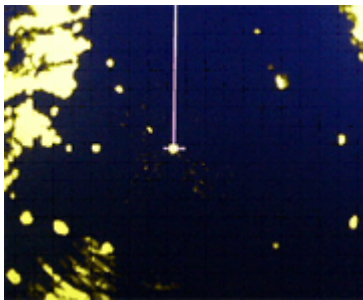

After Adjusted MAN SEA

MAN (manual) SEA and AUTO (automatic) SEA are provided for anti-SEA function. On the rough sea, SEA clutter noise appears around antenna position (center spot), and short distant targets are masked and not recognizable. In that case, anti-SEA function suppresses sea clutter noise and reveals masked target echoes. Recommended adjustment of anti-SEA is to adjust to make echoes from sea clutter vaguely displayed by low (weak) level. If anti-SEA level is too high to show sea clutter noise, short distance gain is over suppressed and it may result in loss of targets like buoys and small ships.

On the other hand, if anti-SEA level is too low, clutter noise around antenna position (center spot) is displayed by high intensity level and it makes difficult to discriminate small ships and buoys from sea clutter.

Anti-SEA is effective to suppress false echoes and ground clutter in short distance. However adjustment of GAIN should be used beyond effective coverage of anti-SEA.

If target echoes are masked by excessive false echoes within anti-SEA effective area, then adjust MAN SEA to confirm it. Excessive anti-SEA may lose echoes from small ships and buoys. So, return to appropriate anti-SEA level for normal use.

Note:

- Small targets become harder to detect when [SEA] is used together with [RAIN]. Therefore, please adjust them carefully.
- The echo process (refer to 2.23 Echo process) is useful to reject sea clutter. Be careful, when the echo process is active, high speed targets are harder to detect than stationary ones.

Selection of MAN SEA and AUTO SEA

By **SEA** knob

When the **SEA** knob is pressed, **AUTO SEA** and **MAN SEA** change alternately.

By trackball/joystick

- 1 Move CURSOR on the **MAN** or **AUTO** display (whichever is shown) at right side of [SEA] on the top of the display.
- 2 Press **ENT** key to display **AUTO** or **MAN** as appropriate.

AUTO adjustment of SEA

When **AUTO SEA** is set, anti-SEA is adjusted automatically.

Note: AUTO SEA may erase weak target echoes. If excessive sea clutter erasing or too much clutter is observed, turn **SEA** knob clockwise or counterclockwise to adjust AUTO SEA effectively.

If not setup properly, adjust it by referring to 4.4.3 Setup GAIN MIN and MAX mode of Installation manual.

In case there are strong echo targets such as in the harbor or canal, anti-SEA tends to suppress excessively, use MAN SEA in that case.

Manual adjustment of SEA

When **MAN SEA** is selected, anti-SEA can be adjusted manually.

By using **SEA** knob, suppress this effect and make targets seen easier.

[SEA] state is displayed in the upper right of the display.

- 1 Turn **SEA** knob clockwise to increase anti-sea clutter effect.
Turn **SEA** knob counterclockwise to decrease anti-sea clutter effect.
- 2 Turn **SEA** knob clockwise until even low (weak) SEA clutter is displayed by observing the display.
- 3 Adjust **SEA** knob from time to time to get low (weak) SEA clutter on the display as intensity of sea clutter changes as time passes.



Note:

- When waves do not affect the result, turn the knob fully counterclockwise.
- This function reduces gain in closest ranges. Too much sea clutter may result in actual targets being lost.
- Manual SEA user keep watching and adjusting SEA with changing conditions.
- If SEA and anti-RAIN are used in combination, then small targets will be less visible.

Picture after adjustment with an [Anti-sea clutter] knob

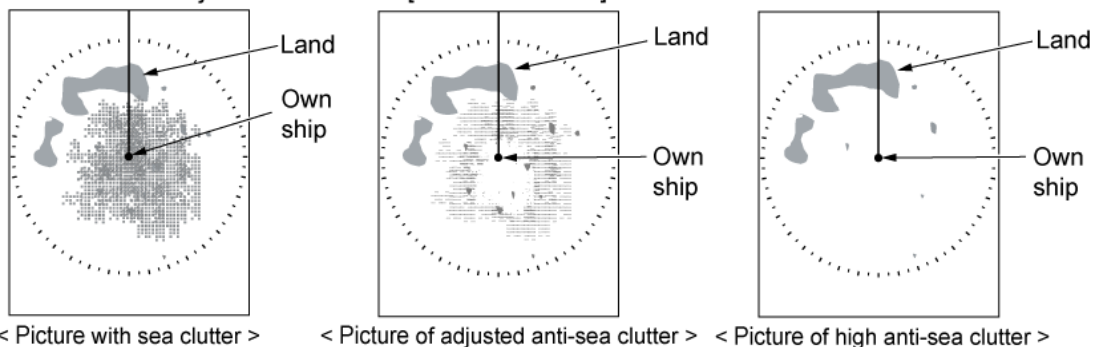

2.8 Reject rain/snow clutter (anti-RAIN)

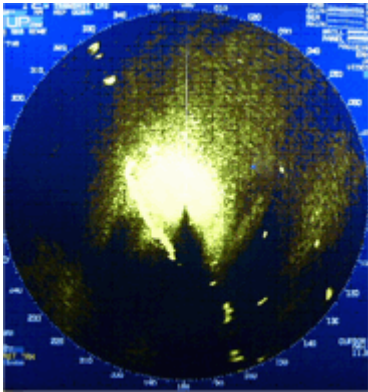

Rain clutter

In rain or snow, targets become hard to be seen as a result of unwanted weather reflection.

Rain or snow image appears as a large target echo with surrounding mid gradation rim as shown in the picture.

Anti-RAIN is available MAN and CFAR.

Adjustment of MAN (manual) and CFAR (Constant False Alarm Rate) by turning **RAIN** knob suppresses clutter, and helps to see targets clearly.

MAN is effective for suppression of rain and snow.

CFAR is effective for suppression of sea, rain and snow clutter.

[RAIN MODE] can be changed directly in the upper right of the display without using menu function.

Note:

- Small target becomes harder to detect when **RAIN** is used together with **SEA**. Therefore, please adjust them carefully.
- The echo process (refer to 2.23 Echo process) is useful to reject rain clutter. Be careful, when the echo process is active, high-speed targets are harder to detect than stationary ones.
- The performance of radar detection range is degraded by rain as shown in the figure below.

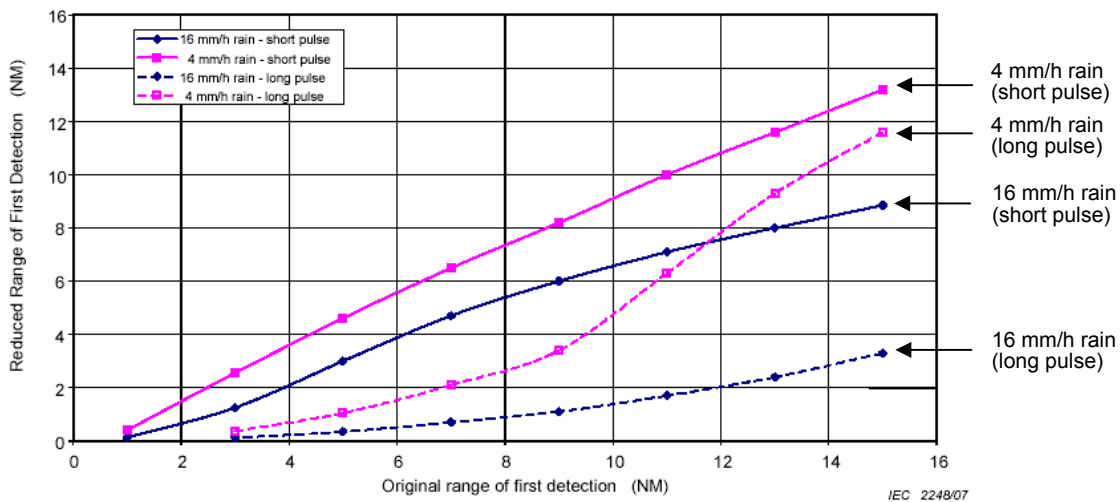

The details of the figure (An example of 6 NM range)

A target which was able to observe at 6 NM (Original range of first detection), can only be detected at the range (Reduced Range of First Detection) shown below in rain condition.

4 mm/h rain (short pulse):	approx. 5.6 NM	4 mm/h rain (long pulse):	approx. 1.5 NM
16 mm/h rain (short pulse):	approx. 3.9 NM	16 mm/h rain (long pulse):	approx. 0.5 NM

Changing method of CFAR and MAN

By **RAIN** knob

When **RAIN** knob is pressed, **MAN** and **CFAR** change because of the alternation.

By trackball/joystick

- 1 Move CURSOR on the **MAN** or **CFAR** display (whichever is shown) at right side of [RAIN] on the top of the display.
- 2 Press **ENT** key to alternate **CFAR** and **MAN**.

CFAR (Constant False Alarm Rate) adjustment

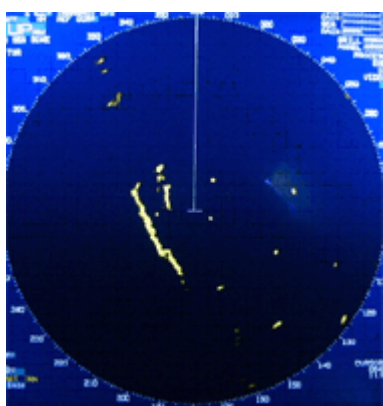

CFAR function is active when **CFAR** is indicated at the upper right side of the display.

CFAR takes priority over MAN (manual) as small target echoes cannot be slimed.

Level of CFAR is indicated on the left side of **CFAR** indication.

After CFAR adjustment

- 1 Turn **RAIN** knob clockwise to increase anti-clutter effect.
Turn **RAIN** knob counterclockwise to decrease anti-clutter effect.



- 2 Turn **RAIN** knob clockwise to get even low (weak) clutter while watching the display.

Note:

- In typical environment CFAR should be turned all the way down via **RAIN** knob, and no white level should be indicated by CFAR window.
- Turning the knob to the right shows the targets hidden in the rain/snow image, but care shall be taken that small target may be hidden and not displayed if over adjusted.
- If there are strong echo targets such as in the harbor or channel, CFAR tends to suppress targets excessively. In that case, change CFAR to MAN and use MAN SEA in addition.

RAIN MAN (manual) adjustment

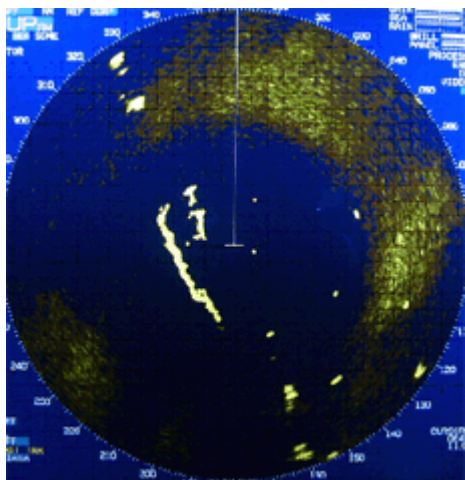

After adjusted anti-SEA

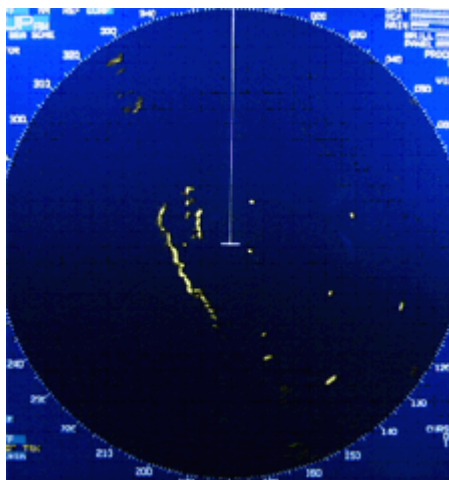

After adjusted anti-SEA & RAIN MAN

- 1 Turn **RAIN** knob clockwise to increase anti-clutter effect.
Turn **RAIN** knob counterclockwise to decrease anti-clutter effect.
Turn **GAIN** knob clockwise until sea clutter is visible on the display.



- 2 Use anti-SEA (AUTO SEA or MAN SEA).
- 3 While observing the display, suppress RAIN clutter outside of anti-SEA effective area by turning **RAIN** knob clockwise. Adjust RAIN so that sea clutter is lightly visible.
- 4 Intensity of RAIN clutter is affected by weather. Adjust by **RAIN** knob according to weather change by watching the display.

Note:

- In typical environment RAIN should be turned all the way down via **RAIN** knob, and no white level should be indicated by RAIN window.
- Turning the knob to the right shows profiles of the targets hidden in the rain/snow image, but care shall be taken that small target may be hidden and not displayed.
- Small target becomes harder to detect when RAIN is used together with SEA.

2.9 Change transmission pulse width (SP/LP)

This radar provides a function capable of achieving suitable target detection by manually changing the transmission pulse width.

Eight different pulse widths are available.

	4 kW		6 kW / 12 kW / 25 kW		IF Band width
	Pulse width	PRF	Pulse width	PRF	
S1	0.08µs	2000Hz	0.08µs	2600Hz	15MHz
S2			0.15µs	2600Hz	15MHz
M1	0.2µs	1800Hz	0.3µs	2400Hz	15MHz
M2	0.3µs	1500Hz	0.4µs	2000Hz	3MHz
M3			0.6µs	1400Hz	3MHz
L1	0.6µs	800Hz	0.8µs	1000Hz	3MHz
L2	1.2µs	500Hz	1.2µs	600Hz	3MHz
L3			1.2µs	450Hz	3MHz

The short (narrow) pulse width used in short range has high resolution and is effective for dense targets.

The long (wide) pulse width used in long range has high gain (sensitivity) and is effective for detecting small targets.

Two different pulse widths are set by default in the following ranges, 0.75NM, 1.5NM, 3NM and 6NM.

Ranges 0.5NM and below, and 12NM and above are setup with same pulse width in SP and LP.

Note: Refer to 2.29 Pulse width to set pulse width.

Range(NM)	0.125	0.25	0.5	0.75	1.5	3	6	12	24	32	48*	64**	96***
SP mode	S1	S1	S1	S1	S2	M1	M3	L2	L2	L2	L2	L3	L3
LP mode	S1	S1	S1	S2	M1	M3	L2	L2	L2	L2	L2	L3	L3

*Maximum range of the initial value at 4kW is 48NM.

**Maximum range of the initial value at 6kW and 12kW is 64NM.

*** Maximum range of the initial value at 25kW is 96NM.

- 1 Move cursor on the **PULSE WIDTH** display, and press **ENT** key. Two different pulse widths are toggled by each key press.

Current pulse width is shown at the upper left of the display.

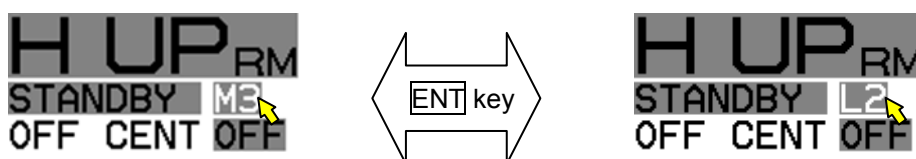

Note: Pulse width can be changed directly to press **SP/LP** key. (MDC-5500 series only)

2.10 Select Display Mode

The display mode is a combination of the bearing indication and the target motion indication.

The bearing is indicated in three ways: **HUP**, **CUP** and **NUP**.

The target motion is indicated in two ways: **RM** and **TM**.

- 1 Move cursor on the **DISPLAY MODE** display, and press **ENT** key.

The display changes in following order by pressing **ENT** key. Current display mode is displayed at the upper left of the display.

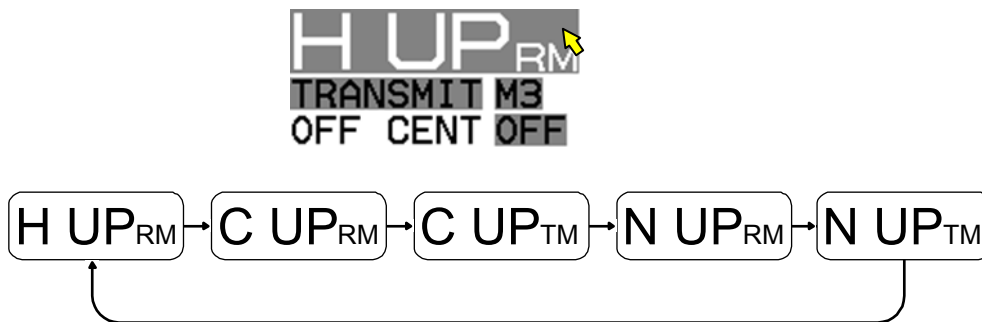

Note: Display mode can be changed directly to press **MODE** key. (MDC-5500 series only)

For H UP (Head up mode)

Heading line is always oriented toward the top of the display.

This mode is based on the bow of the ship and is suitable to monitor targets because targets are seen as they are in navigating own ship.

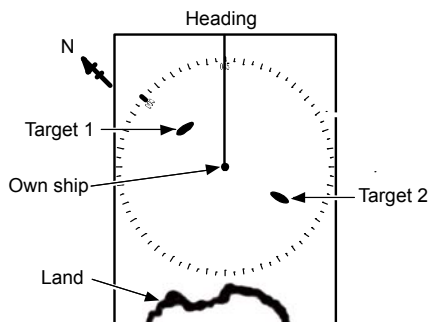

When heading signal is connected, H UP works by stabilized mode. (STAB H UP)

Note:

- This is a presentation mode stabilized in azimuth with fixed origin in which the radar image is oriented “up” toward the top of the bearing scale.
- Radar echoes and tracked targets are shown at their measured distances and moving in a direction relative to own ship’s heading.
- The heading line points from the own ship to the top of the bearing scale showing own ship’s heading in true bearing mode.

For C UP (Course up mode)

When choosing Course up mode, current heading becomes the course at the top of the display and a moving heading line indicates actual.

This mode is used to navigate towards a specified course.

It easily shows any deviation of own ship from the specified course.

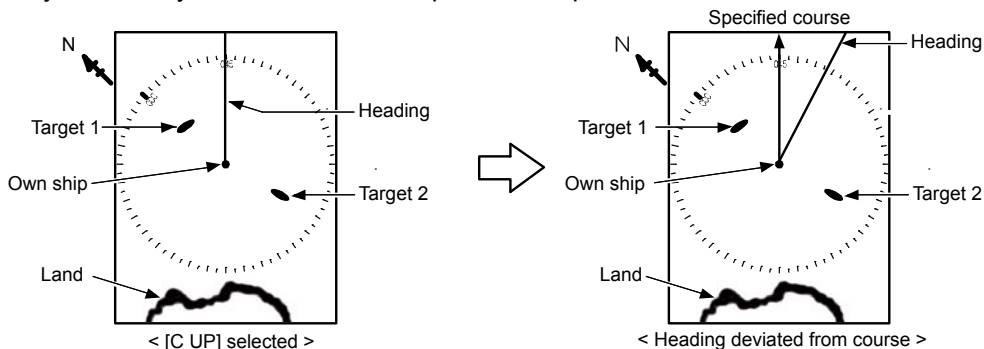

Note:

- This is an azimuth-stabilized presentation in which the bearing scale can be oriented so that own ship's course on the bearing scale is vertically above the own ship.
- The heading line points from the own ship to own ship's referenced heading on the bearing scale.
- If own ship's heading differs from the course, then the heading line does not point vertically upwards from the own ship until the bearing scale is reset (manually or automatically) to reflect the course alteration.

For N UP (North up mode)

This mode always keeps true north at the top of the display.

A north oriented representation makes it easy to reference with a chart.

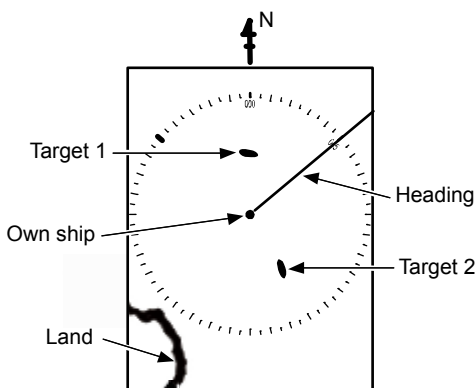

Note:

- This is an azimuth-stabilized presentation in which north on the bearing scale remains fixed vertically above the own ship.
- The heading line points from the own ship to own ship's referenced heading on the bearing scale.
- The true bearing of any target on the display is measured from north.

For relative motion (RM) and true motion (TM)

Relative motion fixes your antenna position at the center of the display, and indicates the motion of targets that surround your antenna position.

Your antenna position is displayed at the center. So, while the ship is moving, the fixed targets such as the land also continue to move.

True motion indicates the motion of the target with respect to the specified bearing.

Fixed targets that do not move in any direction stay on the display, and all the moving targets move on the display.

Note: The heading always continues to move. So, no true motion **TM** is available for **HUF**.

Relative motion (RM): The antenna position is fixed and the other surrounding targets move on the display.

This is useful to monitor the surrounding situation with respect to own ship's position.

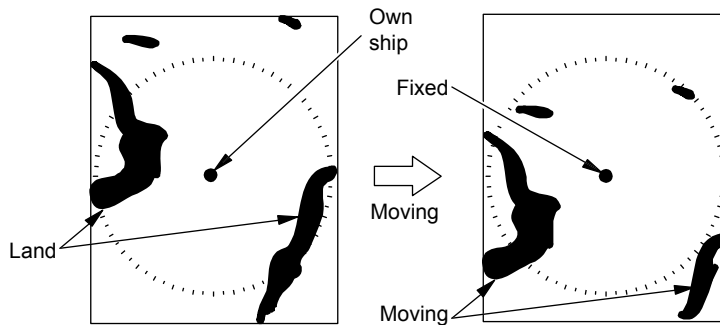

True motion (TM): The antenna position on the display moves according to its speed and tidal current.

Stationary targets are fixed on the display. This mode is useful to monitor your position with respect to the fixed targets such as land.

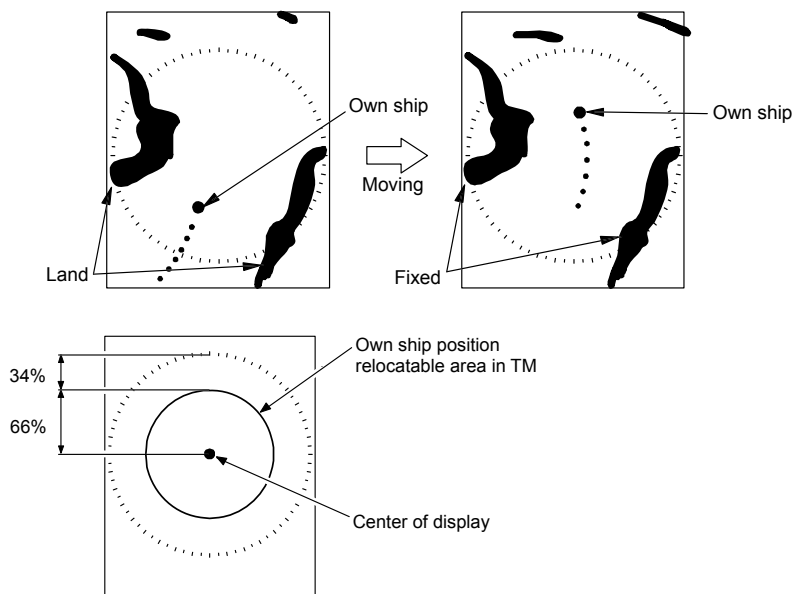

N-UP or C-UP TM mode is selected, own ship position moves to opposite side of heading direction, and begins to show the true motion image. When own ship position reaches center of the range scale, own ship position is to reset to the course over water or to the opposite direction of the course over ground.

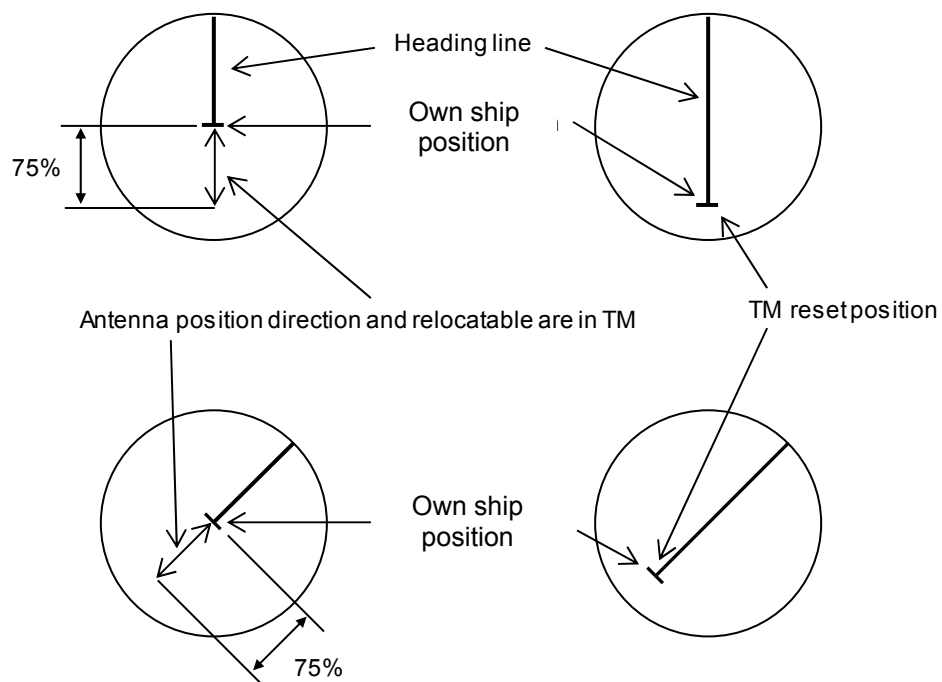

Reset true motion

Own ship display position can be manually reset when in true motion operation at any given point, by following procedure.

Press **MENU** key to display "Menu".

Select **[DISPLAY] => [TM RESET]**, and press **ENT** key.

2.11 Ground and Sea stabilization

STAB MODE is a function to select speed for movement calculation for True trail, TT (ARPA), Past position and True motion (TM).

- 1 Press **MENU** key to display "Menu".
Select **[DISPLAY]** => **[STAB MODE]**, and select **[SEA]** or **[GND]**, and press **ENT** key.

SEA (Sea stabilization)

SEA stabilization uses CTW (course through water) and STW (speed through water) referenced to water.

- STW is relative speed of the ship against water surface in the heading direction.
- Information from gyro (or equivalent) and speed information (VBW or VHW) from water speed sensor like LOG.
- When speed information is interrupted for 30 seconds from NMEA for any reason or VBW water status flag is invalid, then the numerical indication of CTW/STW becomes XXX.X in orange color.
- In this case speed can be entered manually.

Manual speed input.

- 1 Press **MENU** key to display "Menu".
Select **[MAINTENANCE]** => **[I / O]** => **[STW]** => **[STW]** => **[MAN]**, and press **ENT** key.
- 2 Select **[MAINTENANCE]** => **[I / O]** => **[STW]** => **[MAN]**, set manual speed, and press **ENT** key.
- 3 Press **MENU** key to close "Menu".
- 4 Move cursor on the upper side of the speed info of the display.
- 5 Press **ENT** key to get ready for speed entry. Enter speed by using trackball/joystick.
- 6 Press **ENT** key to save the input.

GND (Ground stabilization)

GND stabilization uses COG (course over ground) and SOG (speed over ground) referenced to the ground information from satellite navigation system. Accordingly course and speed indication at the upper right side of the display becomes COG/SOG. Speed in water sensor may be affected by current and stable operation may be spoiled.

- SOG is the absolute speed of the ship with reference to the land.
- If failure of interrupts the speed information for 30 seconds or if the ground status flag or VTG indicator flag is invalid, then the numerical indication of COG/SOG becomes XXX.X in orange color.

2.12 Measurement of distance by RR and VRM

There are three ways to measure distance to a target: Range Rings, Cursor or VRM.

Display Range Rings (RR)

Range rings (RR) are markers displayed at the specified distance from reference point.

They are used as a rough indication of the distance to a target.

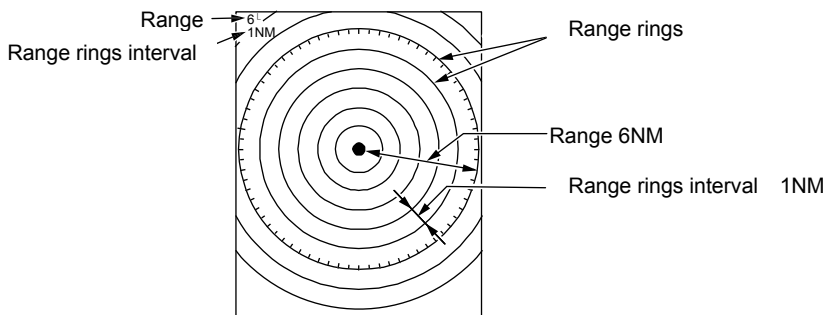

- 1 Press **[MENU]** key to display “Menu”.
 Select **[NAV TOOL]** => **[RR]** => **[RR]** => **[ON]**, and press **[ENT]** key.

Note: **[RR]** display can be changed directly in the upper left of the display, by moving cursor and pressing **[ENT]** key.

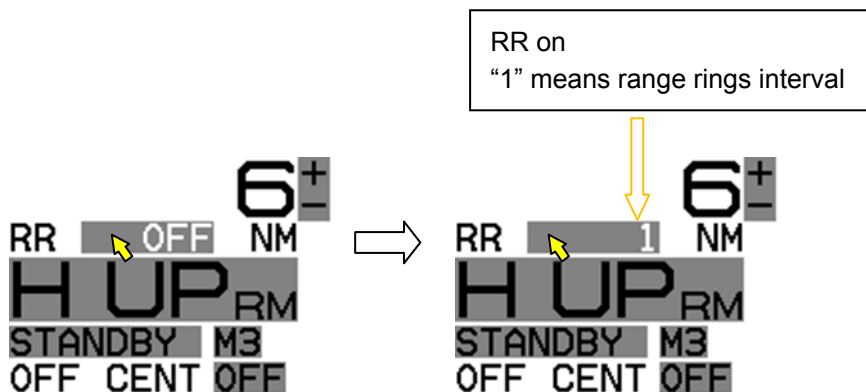

Note: When **[NAV TOOL]** => **[BRG TRUE / REL]** => **[TRUE]** is selected, 0° of the range rings indicates North direction.

While, when **[REL]** is selected it indicates heading direction.

Measurement Range (VRM: Variable Range Marker)

Two variable range markers [VRM1] and [VRM2] are provided.

Turn [EBL/VRM] knob (MDC-5200 series) or [VRM] knob (MDC-5500 series) and lay each circle on the desired target to read the distance to the target on the display.

- 1 Press [VRM1] key to display a dashed line circle of VRM1.
The distance to the target is indicated at the lower right of the display, and also a ► symbol is displayed on the left side of the distance value.
- 2 The dashed line circle is zoomed in or zoomed out by turning [EBL/VRM] knob (MDC-5200 series) or [VRM] knob (MDC-5500 series) clockwise or counterclockwise, respectively.

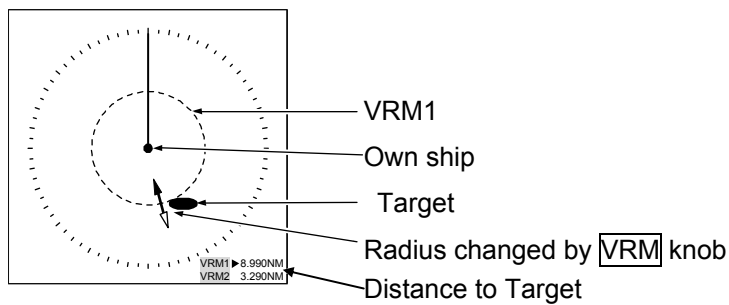

Note: Turning the knob (while pressing it) changes the range quickly.

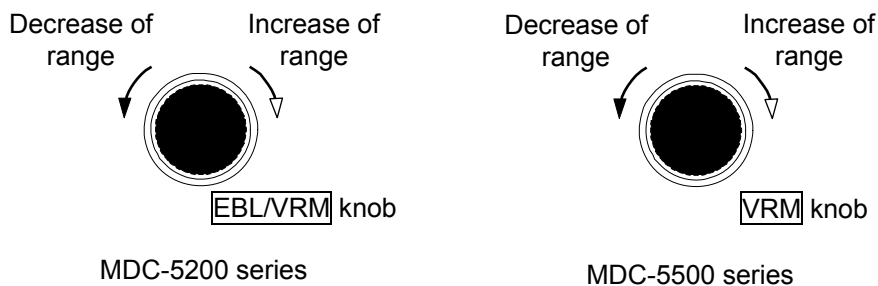

- 3 Another press of [VRM1] key will make the circle disappear.
- 4 Press [VRM2] key to activate the dotted line circle of VRM2.
Operation procedure and distance display are the same as VRM1.
- 5 If you want to display both VRM1 and VRM2 simultaneously, press [VRM1] key and [VRM2] key.
Then, both the dashed line circle and the dotted line circle are displayed.
- 6 Switching between VRM1 and VRM2 is performed with pressing either of [VRM] keys as desired.
When the selected key is pressed, the color of operation panel changes to red. (MDC-5500 series only)

2.13 Measurement of bearing by EBL

This feature is used for measuring the bearing of the target from the base point (reference point for default value.) Two electronic bearing lines [EBL1] and [EBL2] are provided.

Turn **[EBL/VRM]** knob (MDC-5200 series) or **[EBL]** knob (MDC-5500 series) and lay each bearing line on the desired target and read the bearing on the display.

[Bearing mode] can be changed directly in the lower left of the display, by cursor and **[ENT]** key, without using menu function.

- 1 Press **[EBL1]** key, and the bearing line of EBL1 is displayed as a dashed line.
The bearing value to the target is indicated at the lower left of the display, and a ► symbol displayed on the left side of the bearing value.
- 2 Rotate bearing line using **[EBL/VRM]** knob or **[EBL]** knob to adjust the line on the desired target.
The bearing value changes at the same time and you can read the bearing of the target.

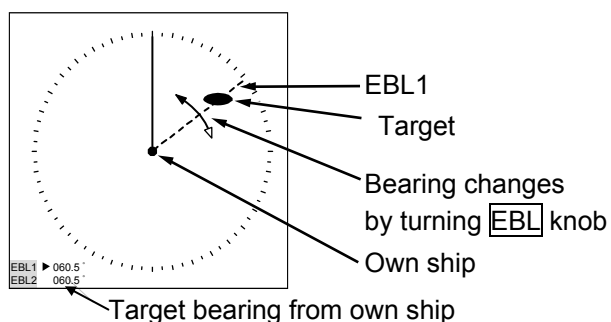

Note: Turning the knob (while pressing it) changes the bearing quickly.

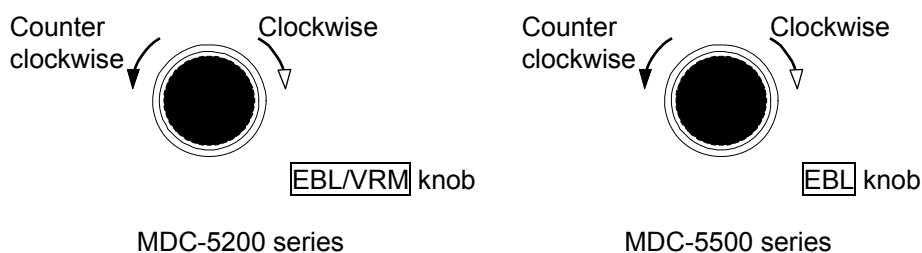

- 3 Another press of **[EBL1]** key, and the dashed line disappears and the bearing value on the lower left of the display also disappears.
- 4 Press **[EBL2]** key, and the bearing line is shown as a dotted line.
The operation procedure and display of the bearing is the same as EBL1.
- 5 If you want to display both EBL1 and EBL2 simultaneously, press **[EBL1]** key and press **[EBL2]** key.
Then, you can show both the dashed bearing line and the dotted bearing line.
- 6 Press **[EBL]** key to switch EBL1 or EBL2 as you desired.
The color of selected **[EBL]** key on the operating panel changes to red. (MDC-5500 series only)

Using the EBL/VRM OFFSET

EBL (and VRM) base point can be changed to any position other than the initial reference point.

By changing the base point, the bearing from a random target can be measured.

- 1 Display the EBL (and VRM) for which the base point is required to be changed.
- 2 Move the cursor to new position.

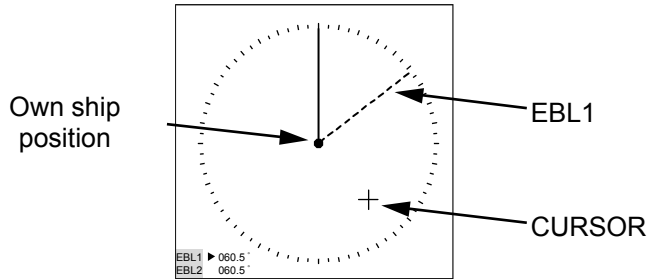

- 3 Press **[EBL/VRM]** knob or **[EBL]** knob, and the base point of EBL (and VRM) changes. During offset, the color of [OFFSET lamp] at the lower right of **[EBL]** knob changes from green to red. (MDC-5500 series only)

The "TM" or "RM" mark is added right of the numerical figures.

"TM" means true motion, and "RM" means relative motion of OFFSET EBL1 and EBL2.

The motion selection can be changed by [NAV TOOL] => [EBL] => [EBL1 OFFSET] or [EBL2 OFFSET] => select [RM] or [TM], and press **[ENT]** key.

EBL knob



↑
OFFSET EBL true or relative motion mark

- 4 Press **[EBL/VRM]** knob or **[EBL]** knob again, and the base point returns to the reference point.

VRM cannot offset alone.

When [NAV TOOL] => [VRM] => [OFFSET] => [ON] is selected, the base point can change a position same as EBL.

2.14 Bearing mode set up

This menu is used to change the bearing mode in EBL, PI, ERBL, Bearing scale and CURSOR.

The settings available in the true bearing with the true north of 000 degree, and in the relative bearing with the heading of 000 degree.

- 1 Press **MENU** key to display "Menu".
 Select **[NAV TOOL]** => **[BRG TRUE/REL]** => **[TRUE]** or **[REL]**, and press **ENT** key.

[EBL], **[PI]**, **[ERBL]** and **[CURSOR]** can be changed directly on the display by using trackball/joystick.

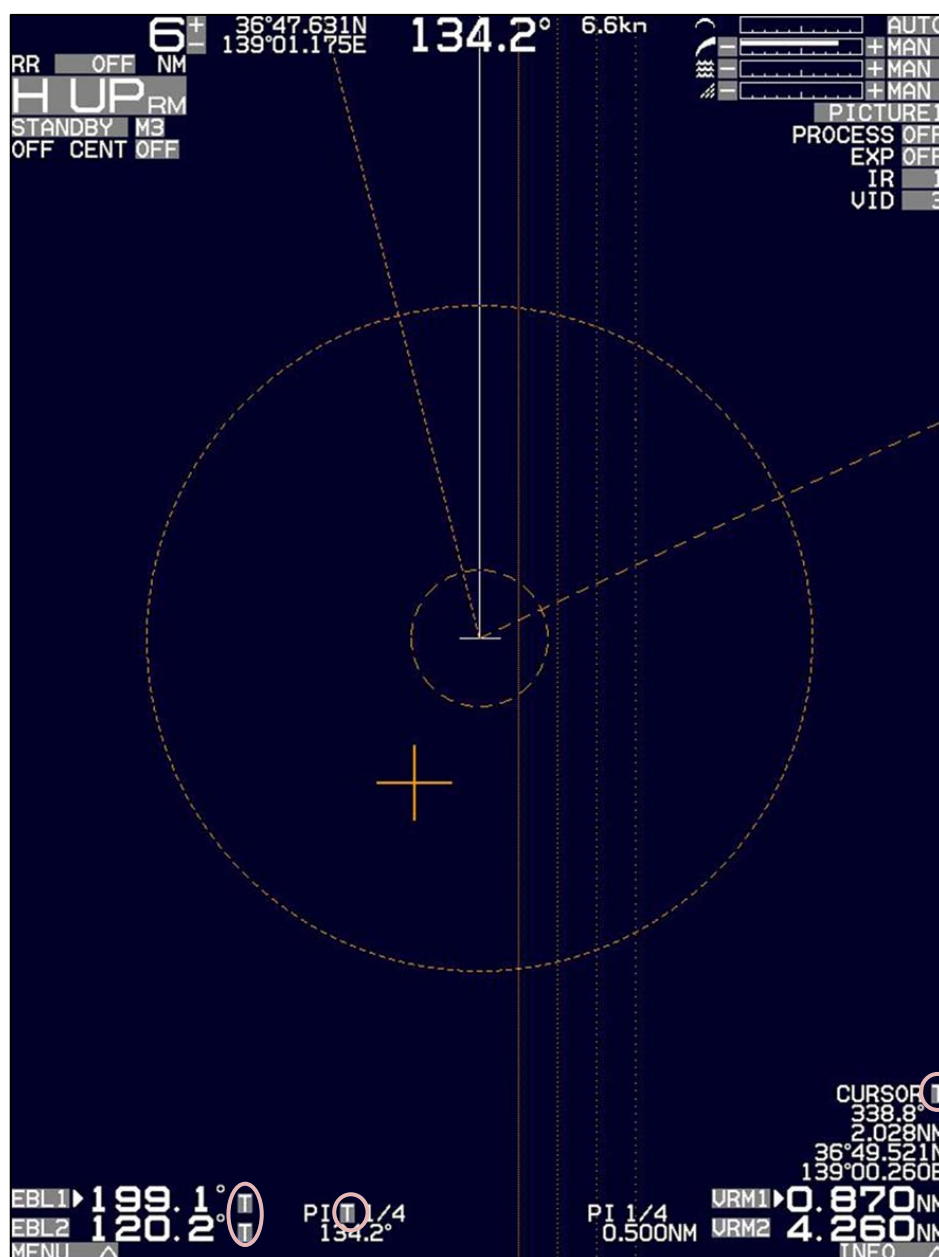

[R] : Relative mode
[T] : True mode

2.15 Measurement of distance/bearing by PI

This function is used to display straight Parallel Index (PI) lines on one or both sides of the vessel, range and bearing of which can be manipulated by following procedures.

PI line number setting

- 1 Press **MENU** key to display "Menu".
Select [NAV TOOL] => [PI] => [CURSOR] => select [NORMAL], [1], [2], [3], [4], [5], [6] or [7], and press **ENT** key.

NORMAL: PI line number is equal to range of range ring. Variable range is min: equal to range ring one, max: 50% of selected range.

1 to 7: Designated number of PI is displayed. Variable range is min: 0, max: about 1.6 times of selected range.

PI display side setting

- 1 Press **MENU** key to display "Menu".
Select [NAV TOOL] => [PI] => [PI DISP SIDE] => select [HALF] or [FULL], and press **ENT** key.

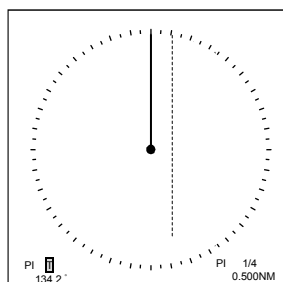

HALF

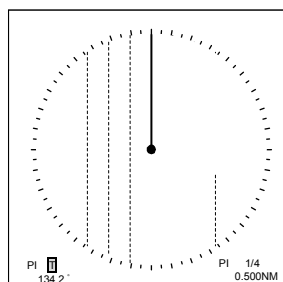

FULL

Operation

(For MDC-5500 series)

- 1 Press **VRM** knob, and PI lines are displayed.
Bearing is displayed by figure on middle lower left of the display, and distance between PI lines is displayed on middle lower right of the display during PI is displayed.
- 2 Turn the **EBL** knob to change the bearing.
- 3 Turn the **VRM** knob to change the interval between lines.
- 4 Press **VRM** knob, PI lines and values are not displayed.

(For MDC-5200 series)

Note: To use PI function, perform the following setting.

[NAV TOOL] => [EBL2/VRM2 KEY] => select [PI].

- 1 Press **EBL2** or **VRM2** key, and PI lines are displayed.

Bearing is displayed by figure on middle lower left of the display, and distance between PI lines is displayed on middle lower right of the display during PI is displayed.



- 2 Press **EBL2** key and turn the **EBL/VRM** knob to change the bearing when ► symbol with PI bearing value.



- 3 Press **VRM2** key and turn the **EBL/VRM** knob to change the interval between lines when ► symbol with PI distance value.



- 4 Press **EBL2** or **VRM2** key displayed ► symbol, PI lines and values are not displayed.

2.16 Measurement distance/bearing by ERBL

The given point of distance and bearing can be measured with the cursor as follows.

Measurement of distance and bearing from reference point can be performed by moving cursor to own ship position.

[Bearing mode] can be changed directly in the lower right of the display, with trackball/joystick and **ENT** key, without using menu function.

(For MDC-5500 series)

- 1 Press **ERBL** key and ERBL is displayed.

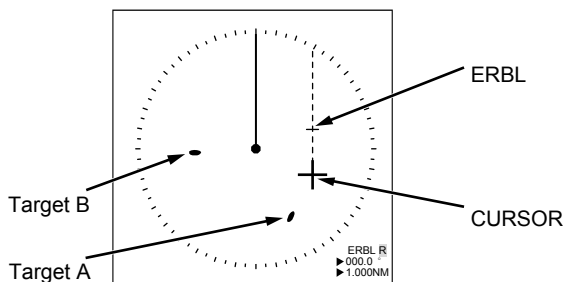

- 2 By moving CURSOR to target A, measurement of distance and bearing from target A to target B can be obtained by using **VRM** knob and **EBL** knob.

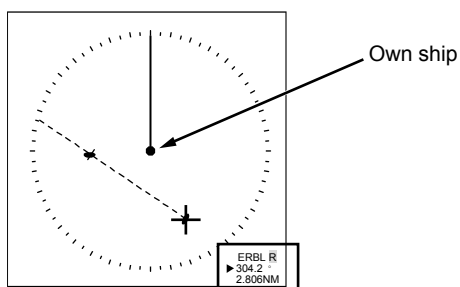

- 3 Pressing **ENT** key (while pressing **OFF** key) returns CURSOR to the own ship position. Therefore, it is possible to measure the distance/bearing from the own ship position.

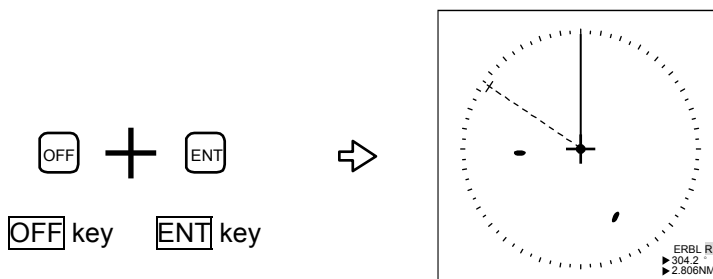

(For MDC-5200 series)

Note: If to use ERBL function, perform the following setting.

[NAV TOOL] => [EBL2/VRM2 KEY] => select [ERBL].

- 1 Press **EBL2** or **VRM2** key and ERBL is displayed.

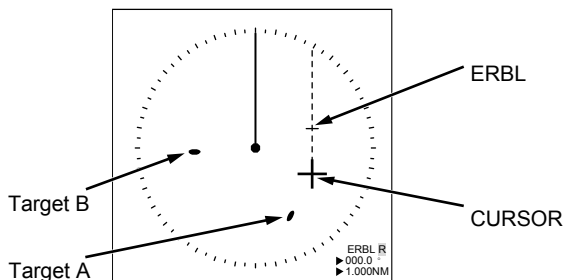

- 2 By moving CURSOR to target A, measurement of bearing from target A to target B can be obtained by using **EBL/VRM** knob, and measurement of distance from target A to target B can be obtained by using **EBL/VRM** knob.

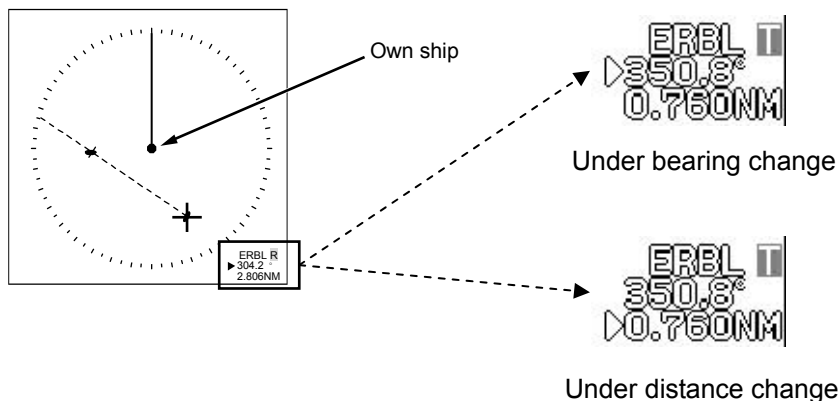

- 3 Pressing **ENT** key (while pressing **OFF** key) returns CURSOR to the own ship position. Therefore, it is possible to measure the distance/bearing from the own ship position.

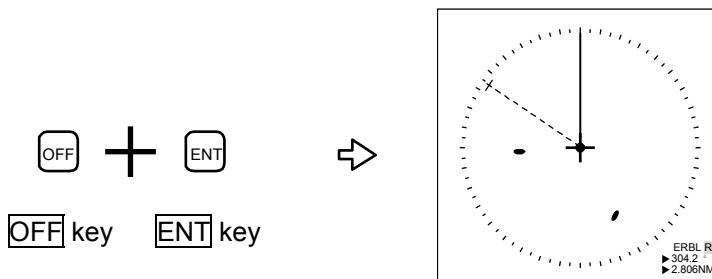

- 4 Press **EBL2** or **VRM2** key displayed ► symbol, ERBL lines and values are not displayed.

Change ERBL mark to LINE or RING

ERBL mark can be changed from LINE to RING.

- 1 Press **MENU** key to display "Menu".
Select **[NAV TOOL]** => **[ERBL]** => **[RNG]** => select **[LINE]** or **[RING]**, and press **ENT** key.

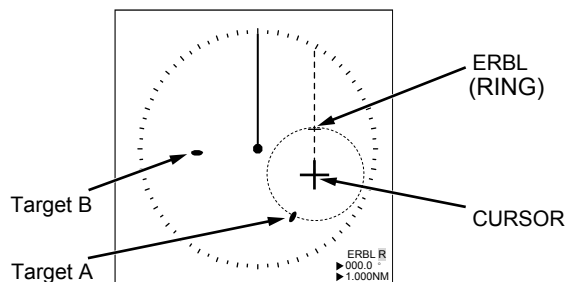
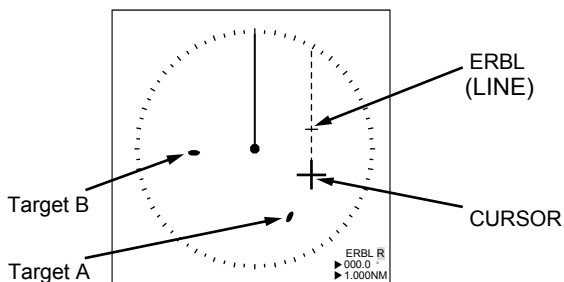

2.17 Change color and brightness (Day/Night)

This function is used to change default echo, trail and all data color and contrast for day and night mode.

- 1 Press **MENU** key to display "Menu".
Select **[BRILL]** => **[DAY/NIGHT]** => Select **[DAY]** or **[NIGHT]**, and press **ENT** key.

Other method (MDC-5500 series only)

Press **DAY/NIGHT** key.

Setup color

- 1 Select the mode (Day or Night), color palette of which you would like to change.
- 2 Press **MENU** key to display "Menu".
Select **[BRILL]** => Select **[ECHO]**, **[TRAIL]**, **[BKGND PPI]**, **[BKGND DATA]**, **[DATA]**, or **[OTHERS]**.
After selecting color for each item, press **ENT** key.

ECHO:	WHITE, YELLOW, GREEN, MULTI, USER1 or USER2
TRAIL:	BLUE, BROWN, USER1 or USER2
BKGND PPI:	BLACK, BLUE, USER1 or USER2
BKGND DATA:	BLACK, BLUE, USER1 or USER2
DATA:	WHITE, GREY, USER1 or USER2
OTHERS	SCALE: NORMAL, DARK, USER1 or USER2
	OS TOOL: NORMAL, USER1 or USER2
	TGT: NORMAL, USER1 or USER2
	COAST LINE: NORMAL, USER1 or USER2
	NAV LINE: NORMAL, USER1 or USER2
	ROUTE: NORMAL, USER1 or USER2
	EVENT MKR: NORMAL, USER1 or USER2
	AREA: NORMAL, USER1 or USER2
	PAST TRK: NORMAL, USER1 or USER2
	MONITORED ROUTE: NORMAL, USER1 or USER2
	LAT/LON LINE: NORMAL, USER1 or USER2
	CURSOR: NORMAL, DARK, USER1 or USER2
	CHART LAND: BROWN, GREEN, LIME, YELLOW, USER1 or USER2
	DEPTH: WHITE, BLUE, USER1 or USER2
- 3 Make sure day or night mode is selected by **[BRILL]** first before making adjustments in step 2.

Setup USER1 and USER2 color

1 Select the mode (Day or Night), color palette of which you would like to change.

2 Press **MENU** key to display "Menu".

Select [BRILL] => Select [USER1] or [USER2].

After selecting the each item, and after adjusting each item with trackball/joystick, and press **ENT** key.

You can change the following item's color.

ECHO:

TRAIL:

BKGND PPI:

BKGND DATA:

DATA:

SCALE:

OS TOOL:

TGT:

COAST LINE:

NAV LINE:

ROUTE:

EVENT MKR:

AREA:

PAST TRK:

MONITORED ROUTE:

LAT/LON LINE:

CURSOR:

CHART LAND:

DEPTH:

	<R>	<G>	
Black	0	0	0
Blue	0	0	255
Green	0	255	0
Light blue	0	255	255
Red	255	0	0
Pink	255	0	255
Yellow	255	255	0
White	255	255	255
Orange	255	152	0
Dark blue	0	0	128
Grey	128	128	128

Combination of representative colors

Setup brightness

This is to set up brightness of ECHO, TRAIL, BKGND, OS TOOL, TGT, MAP CURSOR, DATA, WARNING and ALARM.

Default value of these items is 100 (max).

For safety reason, brightness cannot be adjusted to less than 20.

- 1** Select the mode (day or night), brightness of which you would like to change.
- 2** Press **MENU** key to display "Menu".
Select [BRILL] => Select [ECHO], [TRAIL], [BKGND], [OS TOOL], [TGT], [MAP], [CURSOR], [DATA], [WARNING] or [ALARM]
After adjusting each item with trackball/joystick, press **ENT** key.

Color and brightness settings reset

If you want to return the color and brightness settings back to default value, please use following procedure.

- 1** Press **MENU** key to display "Menu".
Select [BRILL] => [RESET] => [GO], and press **ENT** key.

2.18 Remove the heading line / navigation data

This function is used when a target is overlapped with a heading line and hard to be distinguished.

- 1 Press **OFF** key to temporarily hide the heading line.

For safety reason, the heading line disappears only while the key is pressed. (It is not possible to keep it removed.)

Continue pressing **OFF** key for 2sec. All navigation tool data (RR, EBL, VRM, ERBL, PI, [MAP], such as COAST LINE, NAV LINE, ROUTE, EVENT MKR, and AREA, etc.) will hide.

2.19 Target trail

Other ships trails are displayed by following procedures.

Two display modes, relative display **REL** and true display **TRUE** are available.

Note:

- The trail by its nature records and displays past images. The trail does not display right after transmission is started.

In addition, after the change of [TIME], or after the change of two or more steps in [RANGE], the trail will disappear, because the recording is reset (erased).

- 1 Press **MENU** key to display "Menu".

Select [TRAIL] => [TRUE / REL], and press **ENT** after making selection.

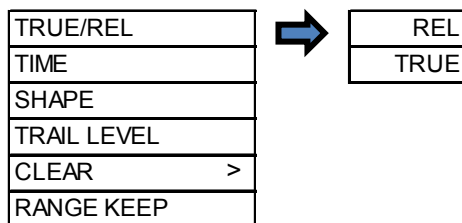

- 2 There are additional set up items, [TIME], [SHAPE], [TRAIL LEVEL], [CLEAR] and [RANGE KEEP].

[TIME]: This is to set up the time of the trail to be displayed.

Initial set up time: OFF, 30sec, 1min, 3min, 6min, 12min, 30min, 60min, PERM

Time setting can be changed by [MAINTENANCE] => [STARTUP] => [TIMES ENABLE] menu operation.

[SHAPE]: Seven types of trail shapes available, as shown below.

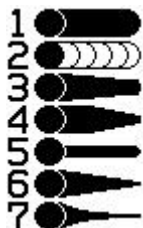

[TRAIL LEVEL]: This is to set up echo level of trail to be recorded.

“1” records all signal levels returned as a trail.

“15” records only the strongest signal levels as a trail.

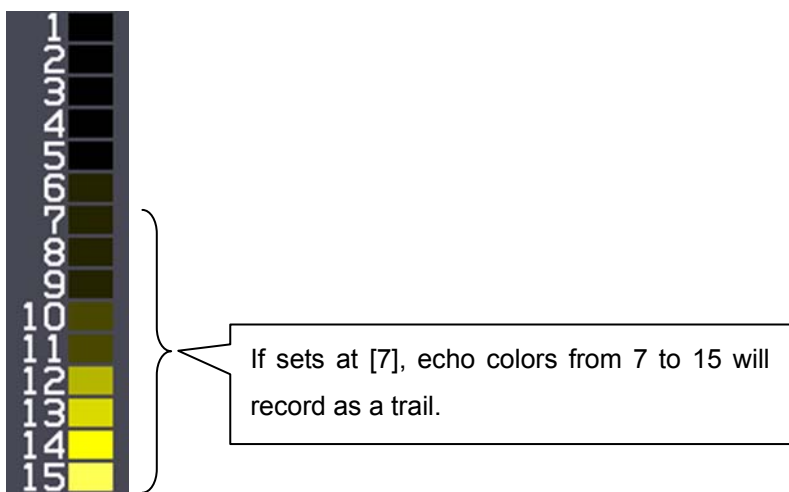

[CLEAR]: This is to delete all current trails and restart new trails.

[RANGE KEEP]: “OFF” deletes trails when changing range.

“ON” does not delete trails when changing range.

Relative display (R)

The target trail is displayed as result of sum of vector (course and speed) of the target ship and your ship. When your ship is on the projected course of this trail, it shows that a collision may occur in future. This display is useful to help detect a dangerous situation.

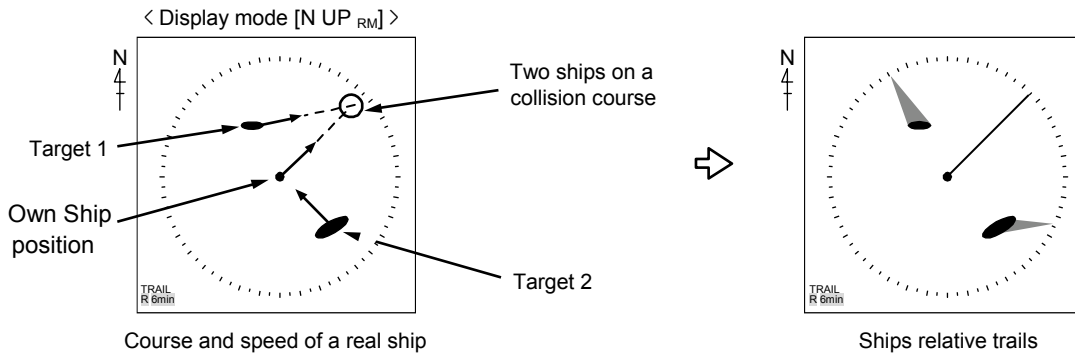

Target 1, whose trail is overlapping the EBL, is a dangerous target while the Target 2 is not. If trail setting is six minutes, and if the trail length is equal to the distance between the antenna position and Target 1, then the collision will occur after six minutes.

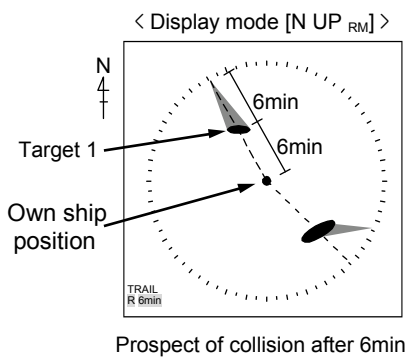

True display (T)

This mode displays the trail of the moving target over a specified time interval independently from own ship's movement.

This mode is used to monitor the bearing and speed of the target. No trails of fixed targets such as land are shown using this display.

The amount of movement of all ships, own ship, Target 1 and Target 2 are drawn as trails. The land does not move, so its trail is not shown.

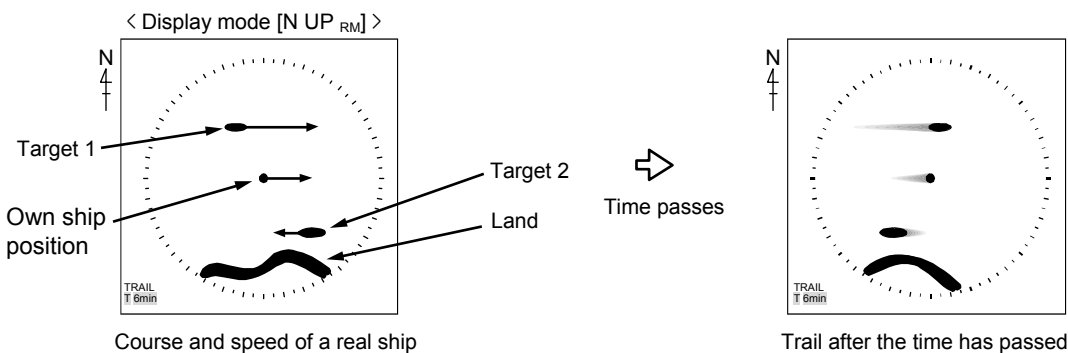

2.20 Off Center

This function is used to get larger view in heading direction.

Two ways "OFF CENTER" can be setup.

[CURSOR]: Off-centering to CURSOR direction.

[OPPOSITE]: Off-centering to the stern direction.

- 1 Press **MENU** key to display "Menu".
Select [DISPLAY] => [OFF CENT POINT] and press **ENT** key after selecting the off center point "CURSOR" or "OPPOSITE".
- 2 Off-centering is executed by select [DISPLAY] => [OFF CENTER],
and press **ENT** key.
Off-centering is executed by pressing **OFF CENT** key. (MDC-5500 series only)

Other method

Move cursor to set value of **ON** or **OFF** of [OFF CENT] at the upper left part of the display, and press **ENT** key.



- 3 The difference of [CURSOR] and [OPPOSITE] are as follows.

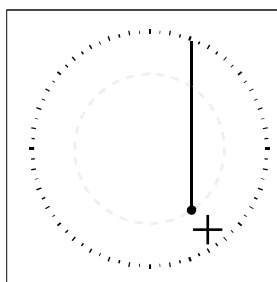
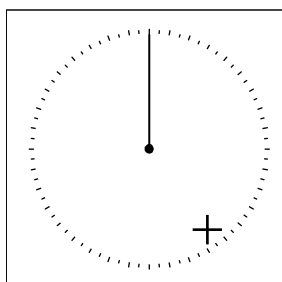

CURSOR

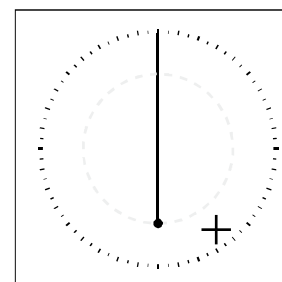

OPPOSITE

2.21 Function key usage

For quick function access, there are plural dedicated function keys provided on this radar.

[F1], [F2], [F3], [F4], [F5] and [F6] : (MDC-5500 series)

[F1], [F2], [F3], and [F4] : (MDC-5200 series)

You can switch to a pre-specified function by pressing each key.

- 1 Press [MENU] key to display "Menu".
 Select [MAINTENANCE] => [STARTUP] => [FUNCTION KEY] => [F1] key => press [ENT] key and after selecting the setup value.

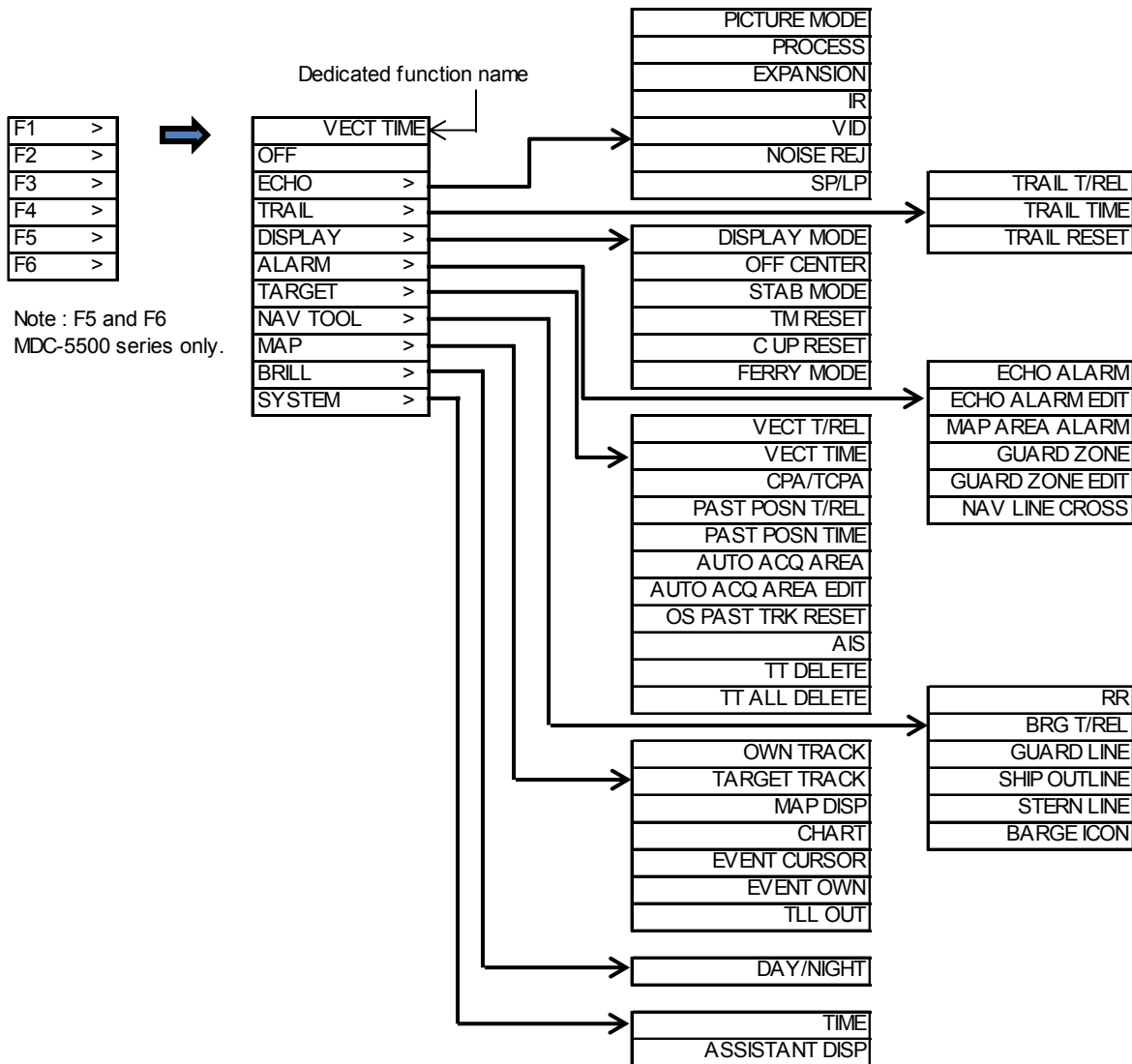

- 2 Follow procedure (1) to setup keys [F2], [F3], [F4], [F5] and [F6] by selecting each item and press [ENT] key.
- 3 Another way to setup each function key is to press and hold desired key until menu selection shows up on the lower left of the display. Using trackball/joystick and [ENT] key make a selection and save to designated function key.

2.22 Set picture mode

It is necessary to make adjustment to the radar picture as environment and sea condition changes. The Picture mode can quickly change for different settings, [PROCESS], [EXPANSION], [IR] and [VID], depending on the situation. You can change these setting items individually, and these changes are stored in internal memory.

- 1 Press **MENU** key to display "Menu".
 Select [ECHO] => [PICTURE MODE] => press **ENT** key after making your selection.

The setting value can be selected from "PICTURE1, PICTURE2, PICTURE3, NEAR, FAR, HARBOR, ROUGH SEA, RAIN or PURE".

	PROCESS	EXPANSION	IR	VID
PICTURE1:	OFF	OFF	1	3
PICTURE2:	C2	2	OFF	2
PICTURE3:	C2	1	OFF	1
NEAR:	OFF	OFF	1	1
FAR:	C1	2	OFF	4
HARBOR:	C1	1	2	1
ROUGH SEA:	C2	OFF	1	1
RAIN:	C1	OFF	1	1
PURE:	OFF	OFF	OFF	1

- PROCESS: Refer to 2.23 Echo process
- EXPANSION: Refer to 2.24 Echo expansion
- IR: Refer to 2.25 Interference rejection (IR)
- VID: Refer to 2.26 Video contrast

[PICTURE MODE] can be changed directly at the upper right of the display using trackball/joystick.

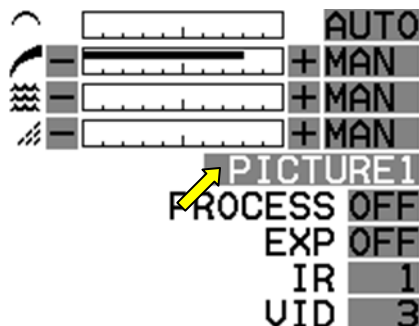

2.23 Echo process

Echo process mode feature reduce sea clutter effectively. Echo process mode is used correlation method. Three types of 1, 2 and 3 are available.

[PROCESS] mode can be changed directly at the upper right of the display using trackball/joystick.

- 1 Move the cursor to **OFF**, **C1**, **C2**, **C3**, **A1** or **A2** of [PROCESS] at the upper right part of the display. Press **ENT** key repeatedly until the desired choice appears.



Correlation image echo process

At setup value of C1, C2, C3, A1 and A2, correlation images are averaged.

When there is a stable image such as a ship among sporadic images such as sea clutter, the sea clutter is reduced by averaging to leave the stable image.

Due to the averaging process, even though stable strong images appeared just after transmission, they are displayed weaker and gradually turn into strong images.

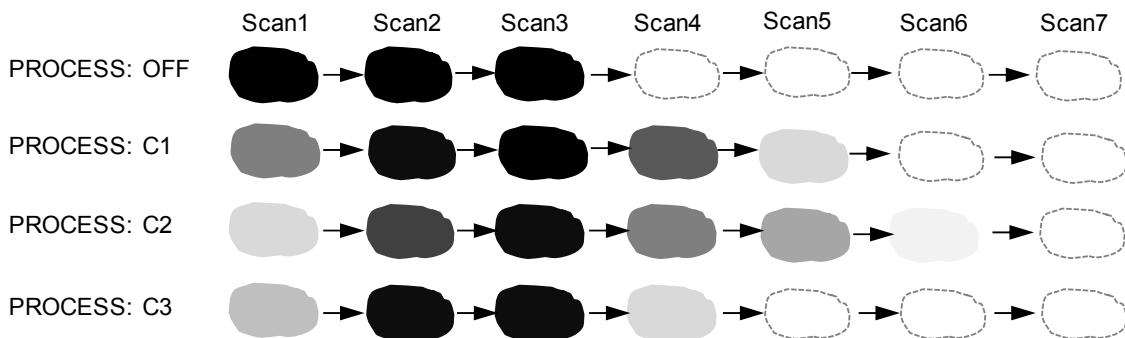

Display of correlation image process in the case when an image appeared and disappeared.

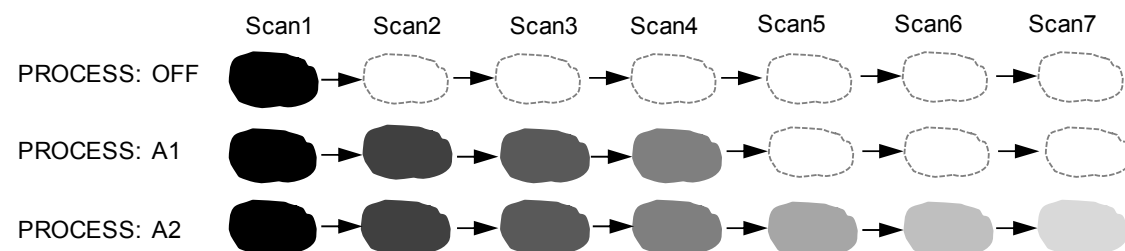

Display of after image process when an image was caught with Scan1 only.

Note:

- For confirmation of an image that may be hidden between the waves and the image of a fast ship that appears at a different position for each scan, the image may be displayed weaker than the actual one. Therefore, when fast moving target on the display, select [PROCESS] **OFF**.
- For operation of GAIN, SEA and RAIN, it may take some time before it becomes effective. Take enough time for the operation, or operate again after [PROCESS] has been once off.
- Echo process mode requires heading signal, echo process mode turns into **OFF** if heading signal is unavailable.

2.24 Echo expansion

This function is to enlarge an image in the direction of distance/bearing.

Small ships and remote targets can be enlarged to be easier to see.

[EXPANSION] can be changed directly at the upper right of the display.

- 1 Move the cursor to set value window of **OFF**, **1**, **2**, **3** or **4** of [EXPANSION] at the upper right part of the display.
Press **ENT** key repeatedly until the desired choice appears.



Note: The setting value can be selected from “OFF, 1 and 2” and the larger value applies stronger enhance effect.



Note: The enlargement of targets has effect on all echoes. So, a large target such as land is also enlarged. Consequently, land and a small target may sometimes be seen as a single target. Pay attention to that.

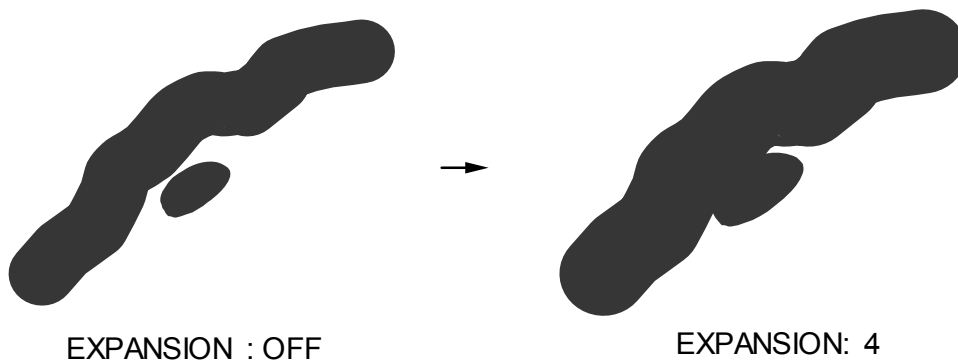

2.25 Interference rejection (IR)

This feature is used to reject interference from other radars.

Radar transmissions on same frequency band can cause interference noise on the display depending on its transmitted power. This noise pattern appearance varies case by case, but is usually spiral shape or like the spokes of a wheel in shape. This function can reduce interference effect.

[IR] can be changed directly at the upper right of the display.

[IR] is also effective to reduce second echo phenomenon.

- 1 Move the cursor to set value window of [IR] at the upper right part of the display.

Press **ENT** key repeatedly until desired value appears.

```

PICTURE 1
PROCESS OFF
EXP OFF
IR 1
VID 3
  
```



Note:

- The setting value can be selected from “OFF, 1, 2, and 3” and the larger value applies stronger interference rejection effect.
- Too much removal effect may also remove small targets. Pay attention to that.

2.26 Video contrast

This is a function to change the relation between the strength of returned echo and their display gradation.

At **VID 1**, the difference of signals strength between strong echo and weak echo becomes larger. As the numerical figure becomes larger in **VID 2**, **VID 3**, **VID 4**, and **VID 5** the difference in signal strength becomes smaller.

[VID] can be changed directly at the upper right of the display.

- 1 Move CURSOR to **1**, **2**, **3**, **4** or **5** of [VID] at the upper right part of the display.

Press **ENT** key repeatedly until desired value appears.

```

PICTURE 1
PROCESS OFF
EXP OFF
IR 1
VID 3
  
```



When the difference of signal strength is small, images becomes sharper.

However, signal strength from small ships and buoys is weak, and the difference between clutter and them is not large enough.

Therefore, it is necessary to display clutter which may blend together with small ships and buoys.

2.27 Noise rejection

This radar is equipped with a function that is capable to remove various signals picked up by the radar such as white noise, and display clean picture.

- 1 Press **MENU** key to display "Menu".
Select [ECHO] => [NOISE REJ] => select [OFF], [1] or [2], and press **ENT** key.

Noise rejection of [2] setting works more effective than [1].

2.28 Echo color rejection

This radar has a function to remove a color selected by menu operation.

This effect is to show the strong signal image clearly and to delete the unwanted signal such as noise.

- 1 Press **MENU** key to display "Menu".
Select [ECHO] => [COLOR REJ] => select [OFF] or [1 to 14], and press **ENT** key.

Selection value 1: Lowest signal level color

Selection value 14: Highest signal level color

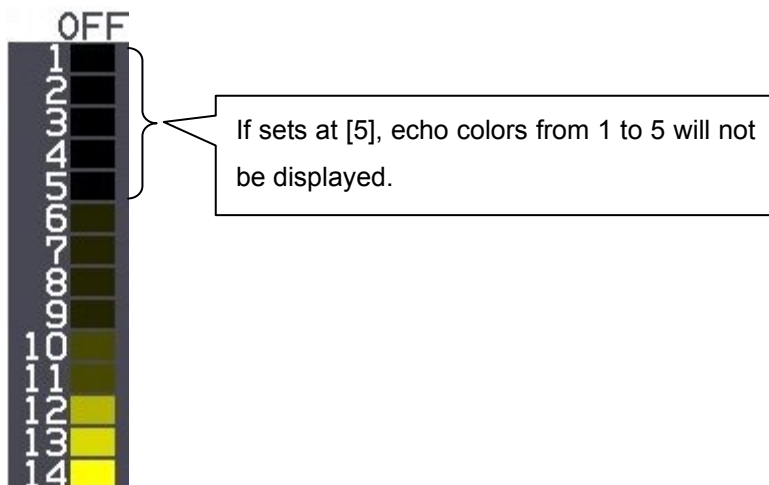

2.29 Pulse width

This radar can change pulse width of the transmission from “SP mode” or “LP mode”.

SP mode : Resolution is given priority to.

LP mode : Gain is given priority to.

- 1 Press **MENU** key to display “Menu”.
 Select [ECHO] => [SP/LP] => select [SP PRIORITY] or [LP PRIORITY],
 and press **ENT** key.

Other method (MDC-5500 series only)

Press **SP/LP** key.

The pulse width in use is displayed at the upper left of the display.

This radar can change pulse width of the transmission from 0.5 NM to 12 NM range scale.

- 1 Press **MENU** key to display “Menu”.
 Select [ECHO] => [PULSE WIDTH] => select range scale (0.5 to 12 NM) => select [SP] or [LP] =>
 set pulse width, and press **ENT** key.

Range	SP mode							LP mode							
0.125	S1							S1							
0.25	S1							S1							
0.5	S1	S2						S1	S2						
0.75	S1	S2						S1	S2						
1.5	S1	S2	M1	M2				S1	S2	M1	M2				
3		S2	M1	M2	M3	L1			S2	M1	M2	M3	L1		
6				M2	M3	L1	L2				M2	M3	L1	L2	
12						L1	L2						L1	L2	
24							L2							L2	
32							L2							L2	
48							L2							L2	
64							L3							L3	
96							L3							L3	

Indication	4kW		6kW / 12kW / 25kW	
	Pulse width	PRF	Pulse width	PRF
S 1 (Short pulse 1)	0.08 μs	2000 Hz	0.08 μs	2600 Hz
S 2 (Short pulse 2)	0.08 μs	2000 Hz	0.15 μs	2600 Hz
M 1 (Medium pulse 1)	0.2 μs	1800 Hz	0.3 μs	2400 Hz
M 2 (Medium pulse 2)	0.3 μs	1500 Hz	0.4 μs	2000 Hz
M 3 (Medium pulse 3)	0.3 μs	1500 Hz	0.6 μs	1400 Hz
L 1 (Long pulse 1)	0.6 μs	800 Hz	0.8 μs	1000 Hz
L 2 (Long pulse 2)	1.2 μs	500 Hz	1.2 μs	600 Hz
L 3 (Long pulse 3)	1.2 μs	500 Hz	1.2 μs	450 Hz

2.30 Inter-switch

Inter-switch is a way to setup two radars to be connected together.

Note: If either radar fails while two radars are in use, then set the [INTER-SWITCH] menu of the working radar to [INDEPENDENT MASTER] and use it independently.

NOTE: [INTER-SWITCH] menu cannot be used while transmitting.

1 Press **MENU** key to display "Menu".

Select [SYSTEM] => [INTER-SWITCH] => select [INTER-SWITCH] mode*, and press **ENT** key.

*Available choices: INDEPENDENT MASTER, INDEPENDENT SLAVE, DUAL MASTER, DUAL SLAVE, CROSS, MONITOR

INDEPENDENT MASTER: Connection status where one antenna is connected to one radar.

INDEPENDENT SLAVE: Connection status where the dedicated cable is connected to the above-mentioned INDEPENDENT (MASTER), and the image of antenna of INDEPENDENT (MASTER) is displayed on (SLAVE) radar.

The SLAVE display unit cannot control the antenna unit. The monitor (SLAVE display unit) will display its range in accordance with the MASTER one.

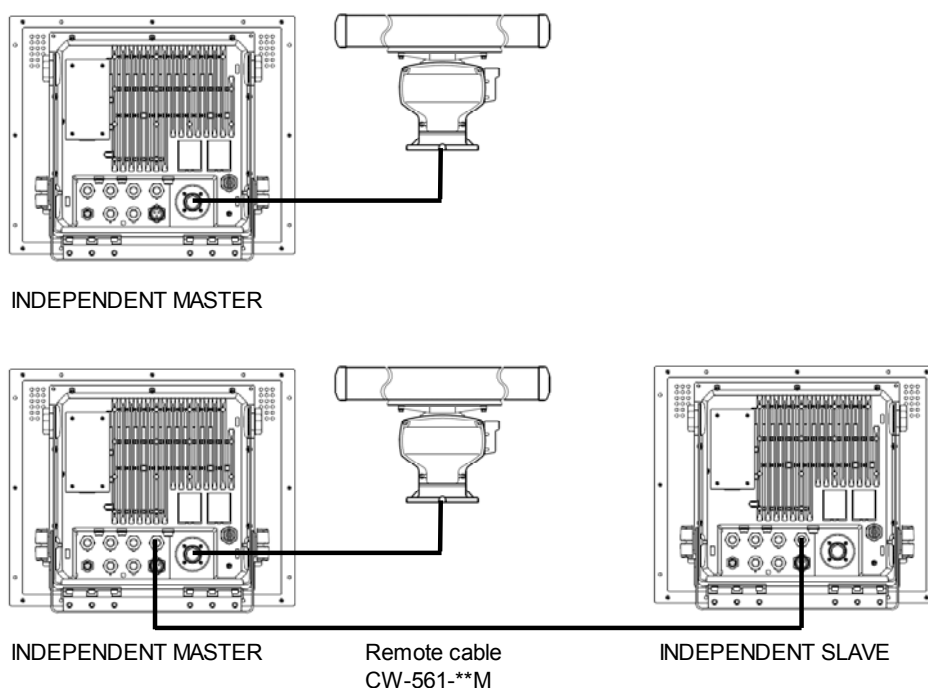

DUAL MASTER: Connection topology is the same as the above-mentioned INDEPENDENT (MASTER) and INDEPENDENT (SLAVE), and the control cable is necessary. By this way, either radar can control the antenna. The radar to which the antenna is connected is DUAL (MASTER).

DUAL SLAVE: The radar to which the antenna is not connected is DUAL (SLAVE).

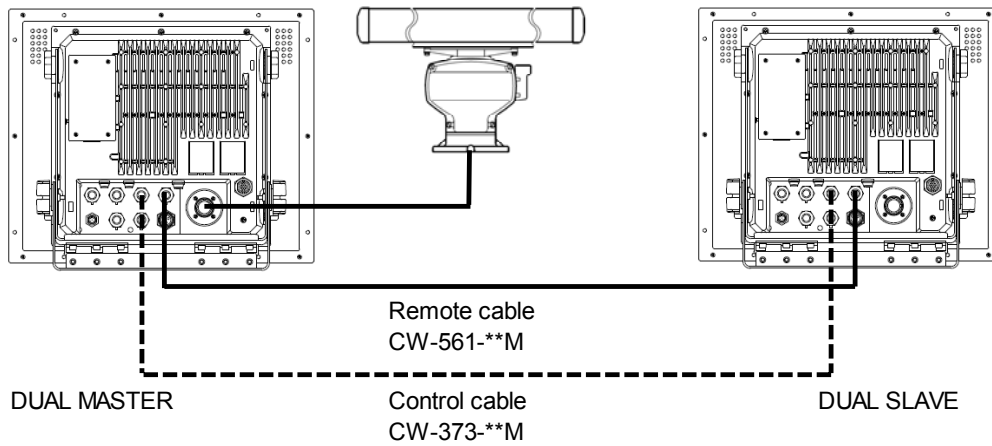

CROSS: In this status, there are two radars to which each antenna is connected.

In this status, the antenna that is not connected to its own radar is used.

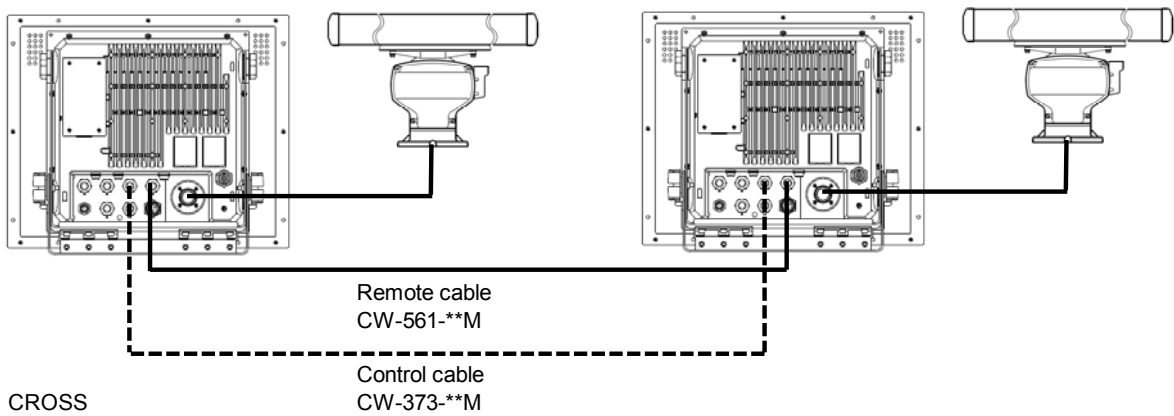

MONITOR: In this status, the antenna is not connected, and a simulator is connected and used.

Note: When you use inter-switch mode at first time, please set Heading (HL OFFSET), TX DELAY and ANT CABLE adjustment of each antenna. (Refer to 4.2.2, 4.2.3 and 4.2.4 of Installation manual) These setting data are memorized in non-volatile memory, and applied automatically when each antenna is selected.

2.31 Cursor data

Cursor data is displayed in distance and bearing at lower right of the display. In addition, it can also be displayed in latitude and longitude position.

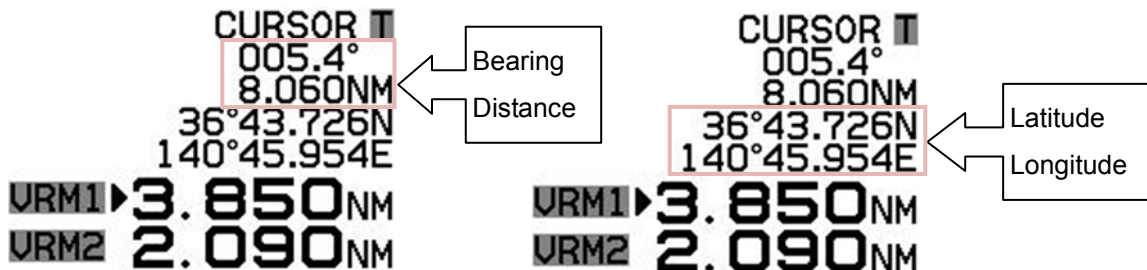

CURSOR setting menu

- 1 Press **MENU** key to display "Menu".
Select **[NAV TOOL]** => **[CURSOR]** =>

CURSOR SHAPE: Set up shape of cursor.

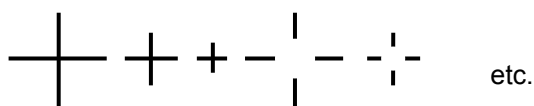

CURSOR: ON /OFF of the cursor indication.

ON: The cursor shape and data are always indicated on the display.

OFF: The cursor shape and date will be disappeared after 30 sec. from last cursor operation.

LAT / LON: ON / OFF of the latitude and longitude position display.

CURSOR HUP MOVE: When HUP mode is used, OFF always remains at the fixed position.

ON links a bearing changes and moves.

INFO: ON / OFF of the TT, AIS and MAP information data display selected by cursor and **ENT** key.

ON: TT, AIS and MAP information data will be displayed near cursor during about 15 sec. after these data is selected.

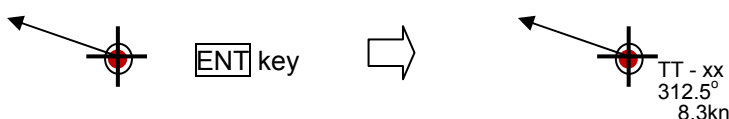

2.32 Setup own ship outline

Setup ship outline

- 1 Press **MENU** key to display "Menu".
Select **[NAV TOOL]** => **[SHIP OUTLINE]** => **[SHIP OUTLINE]** => **[ON]** or **[OFF]**, and press **ENT** key.
[ON]: Display own ship outline
[OFF]: Non display own ship outline.
- 2 Select **[OS PROFILE]** => and => after selection.

This setup is to designate ship's outline.

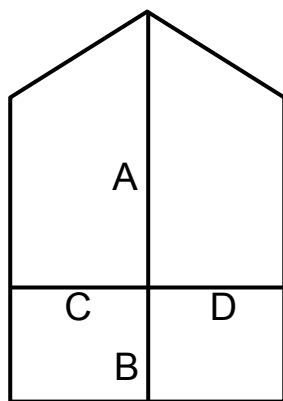

OUTLINE

A	0 - 511m
B	0 - 511m
C	0 - 63m
D	0 - 63m

2.33 FERRY MODE

It is a function to use a river for by coming and going ferry etc.

It becomes effective at H UP, and the letter of the FERRY appears on the screen while using it.

1 Press **MENU** key to display "Menu".

Select **[DISPLAY]** => **[FERRY MODE]** =>

FERRY MODE: OFF, ON

Turn ferry mode on or off.

HDG: 0°, 180°

Gyro reading has 180 degrees added to it or subtracted from it.

HEADING LINE: UP, DOWN

Change of the heading line indication up or down.

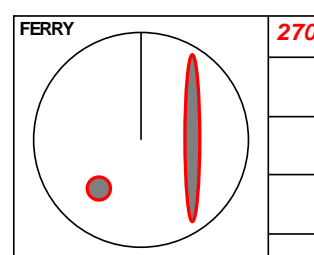
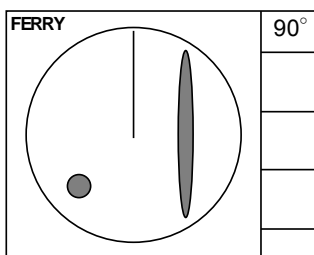
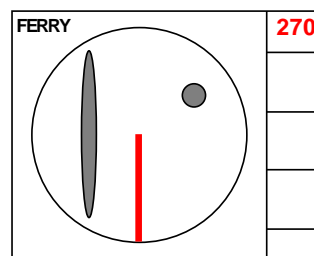
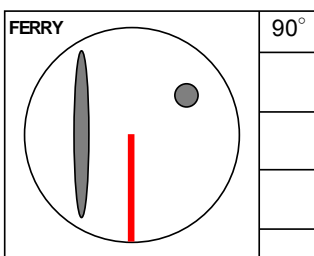
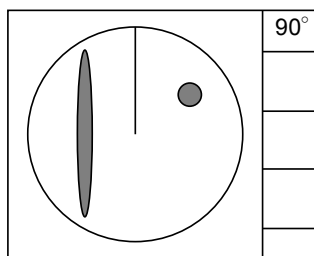
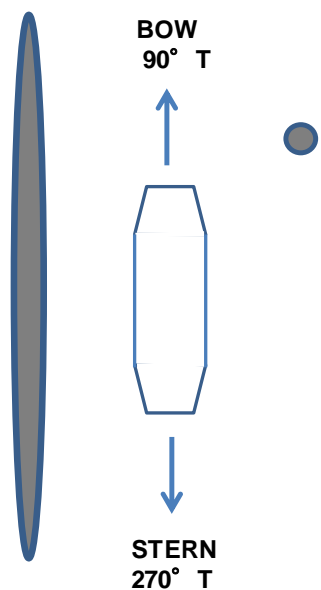

Note: HL line shows the direction that the ship moves.
You can easily change it when you set ferry mode at function key.

2.34 Display setup

2.34.1 ALL PPI mode

ALL PPI function is to display radar echo images, trails, maps and c-map chart on all screens (excluding menu area and own ship's information area).

- 1 Press **MENU** key to display "Menu".
Select **[DISPLAY]** => **[ALL PPI]** => **[ON]**, and press **ENT** key.

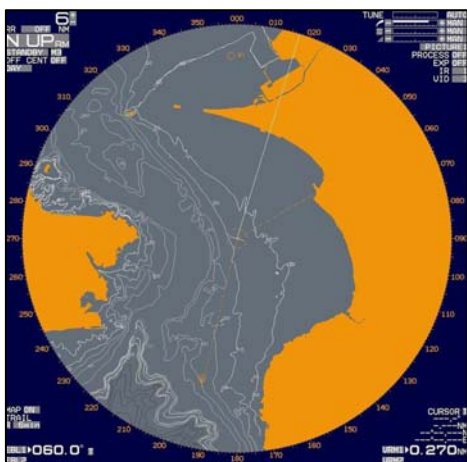

ALL PPI: OFF



ALL PPI: ON

2.34.2 ROTATION MARGIN (H UP, C UP)

This function is to set rotation margin of radar echo images, trails, maps and c-map chart depending on angle of ship's bearing.

When the ship's bearing is changing little by little, the pictures become stable if the set value is larger. In this case, the direction of the heading line moves according to the change of the bearing. When bearing exceeds the set value, the pictures rotate to right position, and heading line returns to the origin position.

- 1 Press **MENU** key to display "Menu".
Select **[DISPLAY]** => **[ROTATION MARGIN]** => **[VALUE]** will show the current setting of the input value by highlighting the last digit value by the trackball/joystick.
- 2 Move the trackball/joystick up or down to set the value. Press **ENT** key to save the set result.
Setting value: 0.0° to 30.0°

2.34.3 ROTATION SPEED

This function is to set the rotation speed of the radar echo images, trails, maps and c-map chart when the ship's bearing has changed.

- 1 Press **MENU** key to display "Menu".

Select [DISPLAY] => [ROTATION SPEED] => select [FAST], [MEDIUM] or [SLOW], and press **ENT** key.

Selection value: FAST, MEDIUM, SLOW

2.34.4 ASSISTANT INFO DISP

This function selects the information to display for "INFO DISP".

There are three "ASSISTANT INFO DISP" areas. (LEFT, CENTER and RIGHT)

"ASSISTANT INFO DISP" areas are displayed lower of the display.

- 1 Press **MENU** key to display "Menu".

Select [DISPLAY] => [ASSISTANT INFO DISP] => select [LEFT], [CENTER] or [RIGHT] =>

Selection value: OWN SHIP INFO, TGT INFO, WAY POINT INFO, DAY INFO, DEPTH / TEMP, WIND, CRS / SPD, SET/DRIFT

This information of "ASSISTANT INFO DISP" area is displayed transparent overlaid on radar display. Please use following procedure.

- 1 Press **MENU** key to display "Menu".

Select [DISPLAY] => [ASSISTANT INFO BKGND] => [OFF], and press **ENT** key.

Refer to 1.1 Radar Display "ASSITANT INFO DISP".

- This page intentionally left blank.-

Chapter 3 Alarm

This function is used to monitor hazardous targets such for collision prevention.

Collision avoidance

It is strongly recommended to maneuver the ship for collision avoidance based on true and dependable SOG and COG information.

This is because ship's heading and running speed against water may be different from the actual ship's movement due to foreign or mostly natural environmental effect such as wind, current, wave etc.

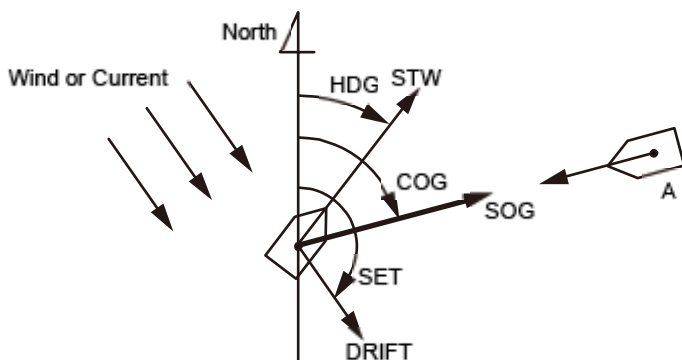

3.1 Echo alarm

Echo alarm function has two movement modes of [IN] and [OUT].

[IN] mode: When the echo enters a specified fan type alarm area, warning message will be displayed at lower right of the display and an alarm will sound.

[OUT] mode: When echoes leave specified fan type alarm area, warning message will be displayed at lower right of the display and an alarm will sound.

How to set echo alarm area. (Fan type)

1 Press **[MENU]** key to display "Menu".

Select **[ALARM]** => **[ECHO ALARM]** => select **[IN]** or **[OUT]**, and press **[ENT]** key.

The color of **[EBL1]**, **[EBL2]**, **[VRM1]** and **[VRM2]** key's light turn red. (MDC-5500 series only)

▶ symbol will be shown at the left of numerical indication of **[BRG REL]** or **[WIDTH]** and **[RNG]** or **[DEPTH]** menu.

Blue dotted line of echo alarm area and orange dashed circle line will be displayed on the display.

```

14 >ALARM
11 ECHO ALARM      IN
12 BRG REL        328 .0°
13 WIDTH          ▶110 .0°
14 RNG            ▶004 .5NM
15 DEPTH          001 .0NM
  
```

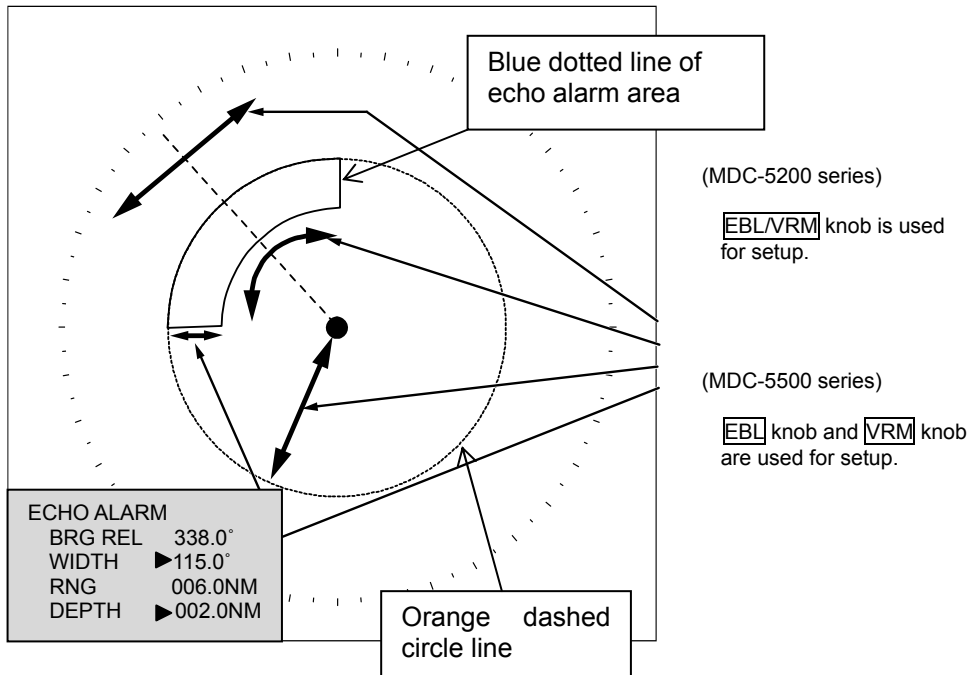

3 Press **EBL1** or **EBL2** key, and select an item to be set between [BRG REL] and [WIDTH] by using **EBL/VRM** knob (MDC-5200 series) or **EBL** knob (MDC-5500 series).

In the same way, press **VRM1** or **VRM2** key, and select an item to be set between [RNG] and [DEPTH] by using **EBL/VRM** knob (MDC-5200 series) or **VRM** knob (MDC-5500 series).

The selected item is shown with a ▶ symbol at the left of numerical indication at the echo alarm in the menu display.

Note: The changing item by using **EBL/VRM** knob will be displayed with yellow characters.

4 When the setting of the echo alarm area is completed, then press **ENT** key, orange dashed circle line will disappear, and echo alarm will be active.

5 There are additional items, [ALARM] => [DETECT LEVEL] => select [1 to 15]

It designates echo strength to determine an alarm sound.

1 means lowest signal echo level, 15 means highest signal echo level.

When the level is set too low, noise may cause false alarm.

Note: [DETECT LEVEL] is applied to the map area alarm function of next section.

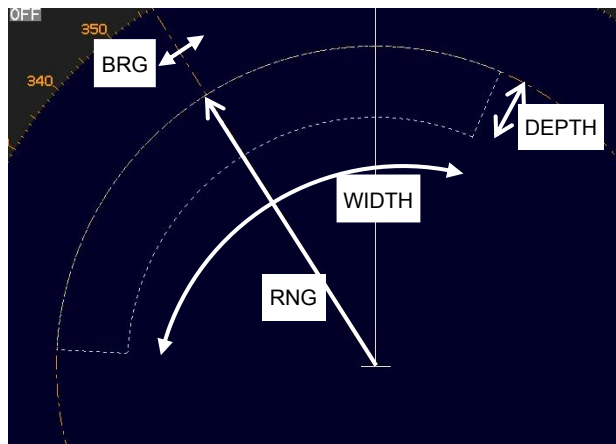

3.2 Map area alarm

Map area alarm function provides alarm display when echo enters or leaves from the MAP AREA.

- 1 Press **MENU** key to display "Menu".
Select **[ALARM]** => **[MAP AREA ALARM]** => select **[IN]** or **[OUT]**, and press **ENT** key.
[IN] mode: When the echo enters a specified map area, warning message will be displayed at lower right of the display and an alarm will sound.
[OUT] mode: When the echo leaves a specified map area, warning message will be displayed at lower right of the display and an alarm will sound.

How to edit map area

There are two methods to edit map area.

First method is to use cursor, second is to input latitude/longitude via the menu.

Example: Cursor method

- 1 Press **MENU** key to display "Menu".
Select **[ALARM]** => **[MAP AREA ALARM]** => **[EDIT]** => **[CURSOR]** => select **[1 to 10]** => **[GO]**, and press **ENT** key.
- 2 Move cursor to first input position, then press **ENT** key.
No.1 mark (small circle) is displayed with numerical number on the display, and numerical data information is displayed in the "AREA INFO" window at lower on the display.
If necessary, Latitude and longitude data can be changed using cursor and **ENT** key by "AREA INFO" window. Also line color can be changed directly by using cursor by "AREA INFO" window. If you want to delete input data, move cursor to word "DELETE", then press **ENT** key.
- 3 Move cursor to second input position, then press **ENT** key. No.2 mark is displayed, and a line is generated from No.1 to No.2.
- 4 Move cursor to third input position, then press **ENT** key. No.3 mark is displayed, and a line is generated from No.2 to No.3 and No.1 to No.3.
You can input up to 100 points. The minimum is three points. When input is completed, press **MENU** key, numerical marks on the display will disappear, and map area alarm will be activated.

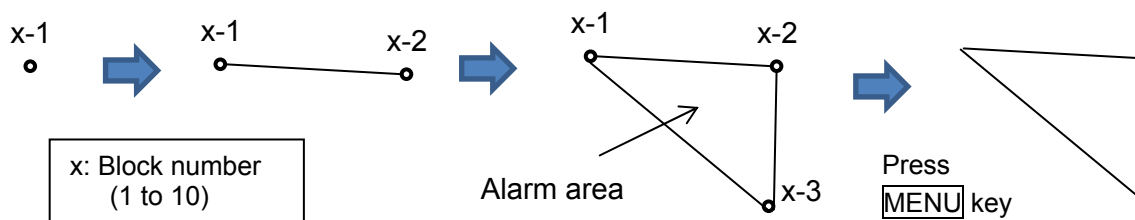

- 5** The procedures to input plural divided map areas in the memory of same block number are as follows. (Example)

After input the one map area (from x-1 to x-3), please input the start point of the new map area (x-4). Press **[OFF]** key to divide the start point (x-4) from the first and last point (x-1, x-3).

Repeat operation of clause 3 and 4 mentioned previously (x-5, x-6).

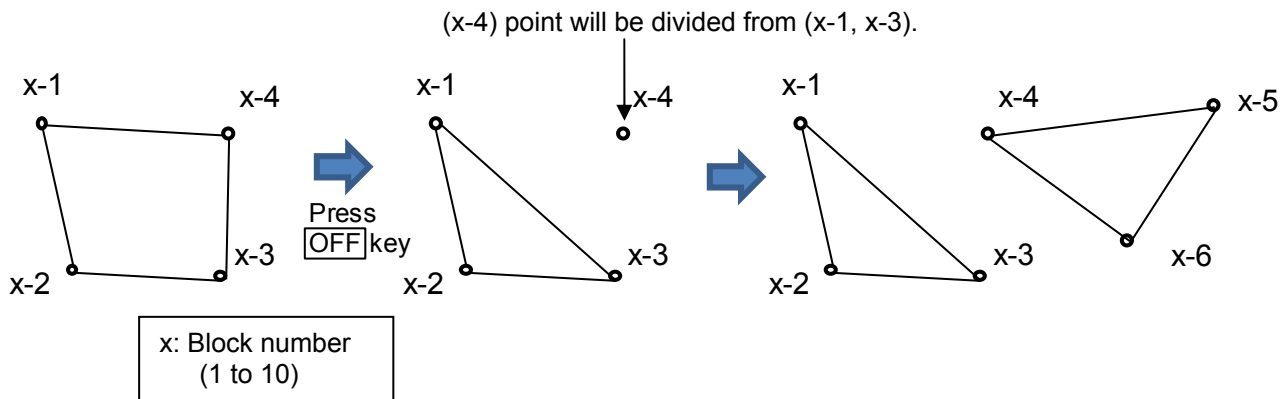

- 6** There are additional items, [ALARM] => [DETECT LEVEL] => select [1 to 15]

It designates echo strength to determine an alarm sound.

1 means lowest signal echo level, 15 means highest signal echo level.

When the level is set too low, noise may cause false alarm.

Note: [DETECT LEVEL] is applied to the echo alarm function in previous section.

How to move map area

There are two methods to move map area position.

First method is to use cursor, second is to input latitude/longitude via the menu.

Example: Cursor method

- 1** Press **[MENU]** key to display "Menu".
Select [ALARM] => [MAP AREA ALARM] => [MOVE] => [CURSOR] => select [1 to 10] => [GO], and press **[ENT]** key.
- 2** Move cursor to the map area mark which you want to move to new position, then change color or delete position data.
- 3** Press **[ACQ]** key, middle circle mark will appear on the selected mark position, and numerical data information is displayed in the "AREA INFO" window at lower of the display.
- 4** Move cursor to new position, then press **[ENT]** key. Selected mark position will move to new position.
Latitude and longitude position data can be changed directly by using cursor and **[ENT]** key by "AREA INFO" window. Line color can be changed directly by using cursor by "AREA INFO" window. If you want to delete selected data, move cursor to word "DELETE", then press **[ENT]** key.
- 5** Repeat operation of clause 2 to 4 mentioned previously.

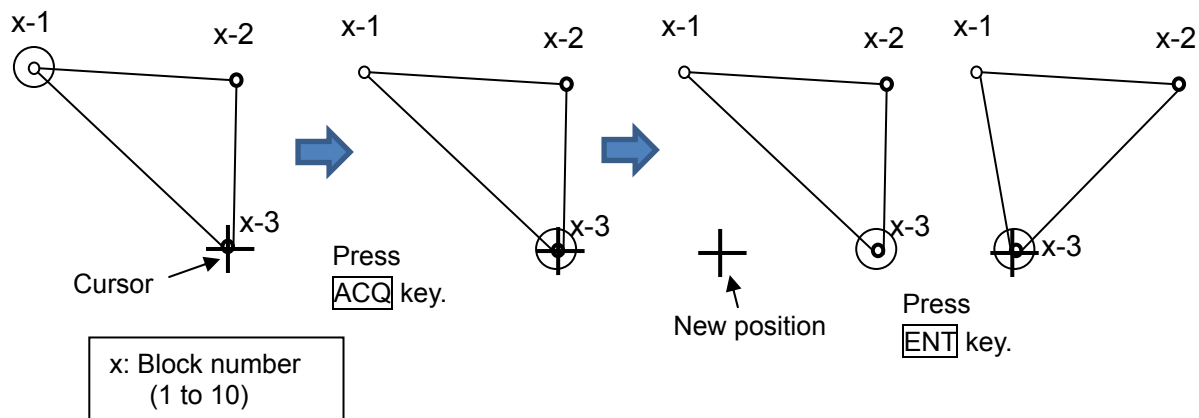

- 6 When move operation is completed, press **MENU** key, numerical marks on the display will disappear, and map area alarm function will be active.

How to add data to map area

There are two methods to add map area alarm position.

First method is to use cursor, second is to input latitude/longitude via the menu.

Example: Cursor method

- 1 Press **MENU** key to display “Menu”.
Select **[ALARM]** => **[MAP AREA ALARM]** => **[ADD]** => **[CURSOR]** => select [1 to 10] => **[GO]**, and press **ENT** key.
- 2 Move cursor on the map area mark before which you want to insert new mark, then change color or delete position data.
- 3 Press **ACQ** key, middle circle mark will appear on the selected mark position, and numerical data information is displayed in the “AREA INFO” window at lower on the display.
- 4 Move cursor to new position where you want to add point, then press **ENT** key. New position point will be inserted on the display.
Selected latitude and longitude position data can be changed directly by using cursor and **ENT** key by “AREA INFO” window. Line color can change directly using cursor by “AREA INFO” window. If you want to delete selected data, move cursor to word “DELETE”, then press **ENT** key.

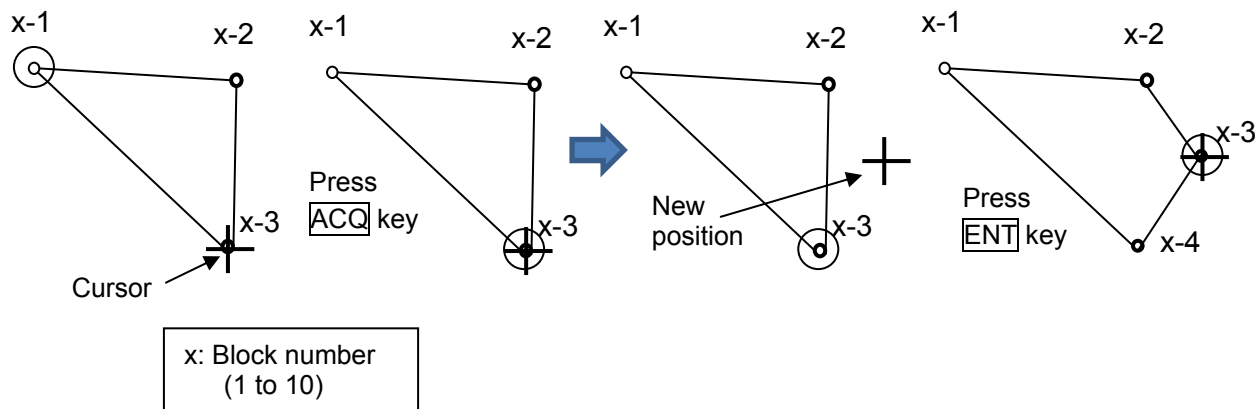

How to delete the data of map area

There are two methods to delete map area alarm position.

First method is to delete the point that is selected by cursor, second is to select the number from the menu.

Example: Cursor method

- 1 Press **MENU** key to display "Menu".
Select [ALARM] => [MAP AREA ALARM] => [DELETE] => [CURSOR] => select [1 to 10] => [GO], and press **ENT** key.
- 2 Move cursor on the map area mark which you want to delete.
- 3 Press **ENT** key.
Selected map area position data will delete.

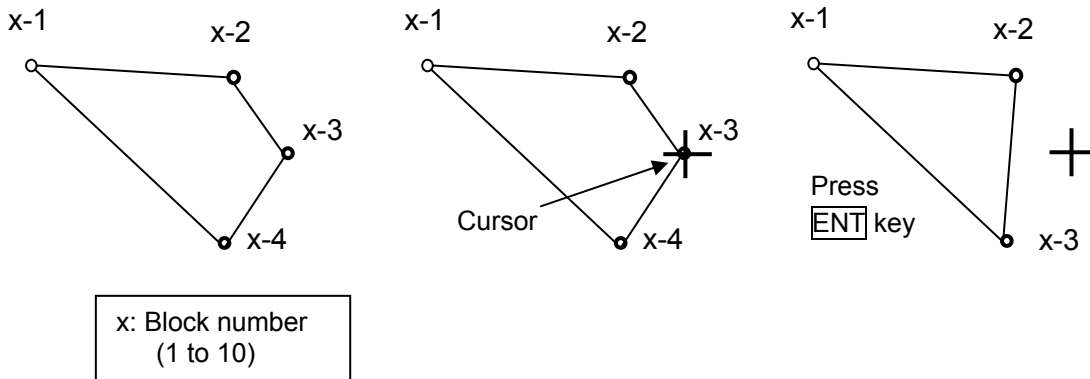

How to clear entire block of map area data

The map area data block can be cleared by using menu operation.

- 1 Press **MENU** key to display "Menu".
Select [ALARM] => [MAP AREA ALARM] => [CLEAR] => [BLOCK NUMBER] => select [1 to 10] => [GO], and press **ENT** key.
Selected map area block will be cleared.

3.3 Guard zone alarm

Guard zone alarm is an alarm system using TT (ARPA) tracked target or an AIS active target signal.

If a TT (ARPA) tracked target or an AIS active target enters a guard zone, then a large, red symbol is displayed and [ALARM] is generated.

If a TT (ARPA) un-tracked target or an AIS sleeping target enters there, then no alarm is generated.

How to set guard zone alarm

- 1 Press **[MENU]** key to display "Menu".
- 2 Select [ALARM] => [GUARD ZONE] => [ON], and press **[ENT]** key.
The color of **[EBL1]**, **[EBL2]**, **[VRM1]** and **[VRM2]** key's light turns red. (MDC-5500 series)
▶ symbol will be shown at the left of numerical indication of [BRG REL] or [WIDTH] and [RNG] or [DEPTH] menu.
Blue dashed line of guard zone alarm area and orange dashed circle line will be displayed on the display.

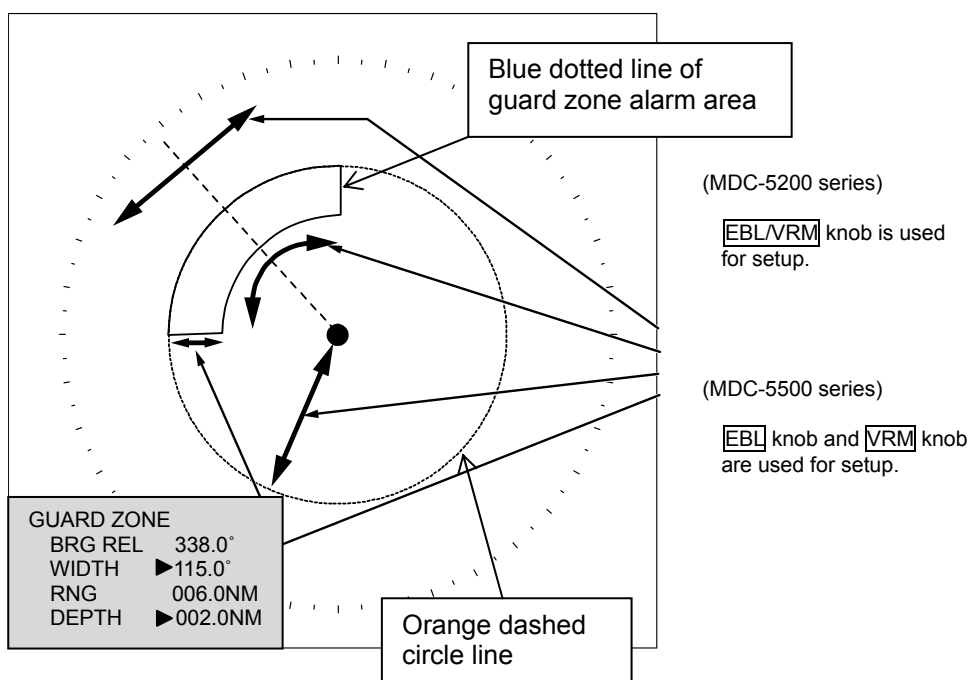

- 2 Press **[EBL1]** or **[EBL2]** key, and Select an item to be set between [BRG REL] and [WIDTH] by using **[EBL/VRM]** knob (MDC-5200 series) or **[EBL]** knob (MDC-5500 series).
In the same way, press **[VRM1]** or **[VRM2]** key, and select an item to be set between [RNG] and [DEPTH] by using **[EBL/VRM]** knob (MDC-5200 series) or **[VRM]** knob (MDC-5500 series).
The selected item is shown with a ▶ symbol at the left of numerical indication at the guard zone alarm in the menu display.
Note: The changing item by using **[EBL/VRM]** knob will be displayed with yellow characters.
- 3 When the setting of the guard zone alarm area is completed, then press **[ENT]** key, orange dashed circle line will disappear, and guard zone area alarm will be activated.

3.4 Nav line cross

Nav line cross function enables to attract attention for safety navigation with alarm display when own ship crosses the course preliminarily set (by cursor or latitude/longitude input).

- 1 Press **MENU** key to display "Menu".
Select [ALARM] => [NAV LINE CROSS] => [ON], and press **ENT** key.

Note: When set [NAV LINE CROSS] menu to [OFF], this data will be displayed as line data of map that looks like coast line.

Refer to 6.4 COAST LINE.

Refer to 6.5 NAV LINE.

How to edit

There are two methods to edit nav line cross alarm.

First method is to use cursor, second is to input latitude/longitude by the menu.

Example: cursor method

- 1 Press **MENU** key to display "Menu".
Select [ALARM] => [NAV LINE CROSS] => [EDIT] => [CURSOR] => select [1 to 10] => [GO], and press **ENT** key.
- 2 Move cursor to first input position, then press **ENT** key. No.1 mark (small circle) is displayed with numerical number on the display, and numerical data information is displayed in the "NAV LINE INFO" window at lower on the display.
If necessary, latitude and longitude data can be changed using cursor and **ENT** key by "NAV LINE INFO" window. Also line color can be changed directly by using cursor and **ENT** key by "NAV LINE INFO" window. If you want to delete input data, move cursor to word "DELETE", then press **ENT** key.
- 3 Move cursor to second input position, then press **ENT** key. No.2 mark is displayed, and a line is generated from No.1 to No.2.
- 4 Move cursor to third input position, then press **ENT** key. No.3 mark is displayed, and a line is generated from No.2 to No.3.

You can input up to 100 points. The minimum is two points. When input is completed, press **MENU** key, numerical marks on the display will disappear, and nav line cross alarm will be activated.

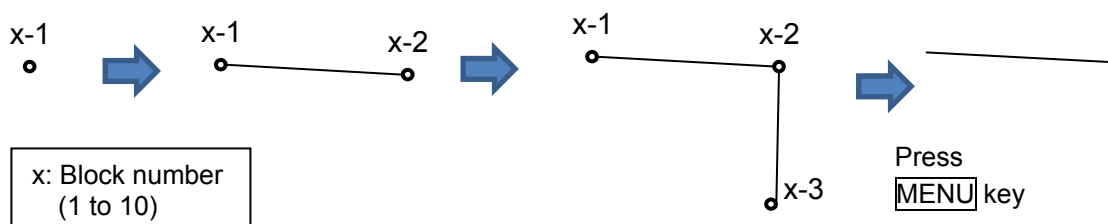

- The procedures to input plural divided nav line in the memory of same block number are as follows.
(Example)

After input the one nav line (from x-1 to x-3), please input the start point of the new nav line (x-4).

Press **OFF** key to divide the start point (x-4) from the last point (x-3).

Repeat operation of clause 3 and 4 mentioned previously (x-5, x-6).

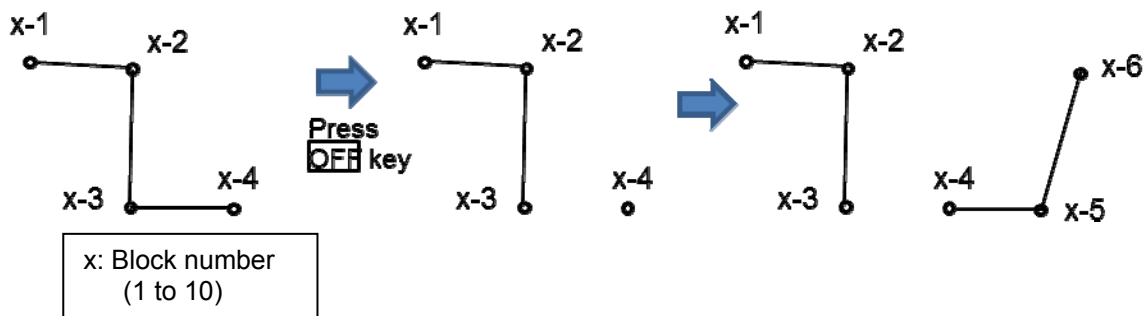

How to move nav line

There are two methods to move nav line cross alarm.

First method is to use cursor, second is to input latitude/longitude by the menu.

Example: cursor method

- Press **MENU** key to display “Menu”.
Select [ALARM] => [NAV LINE CROSS] => [MOVE] => [CURSOR] => select [1 to 10] => [GO], and press **ENT** key.
- Move cursor to the nav line cross mark which you want to move to new position, then change color or delete position data.
- Press **ACQ** key, medium circle mark will appear on the selected mark position, and numerical data information will be displayed in the “NAV LINE INFO” window at lower on the display.
- Move cursor to new position, then press **ENT** key. Selected mark position will move to new position.
Latitude and longitude position data can be changed directly by using cursor and **ENT** key by “NAV LINE INFO” window. Line color can be changed directly by using cursor by “NAV LINE INFO” window. If you want to delete selected data, move cursor to word “DELETE”, then press **ENT** key.
- Repeat operation of clause 2 to 4 mentioned previously.

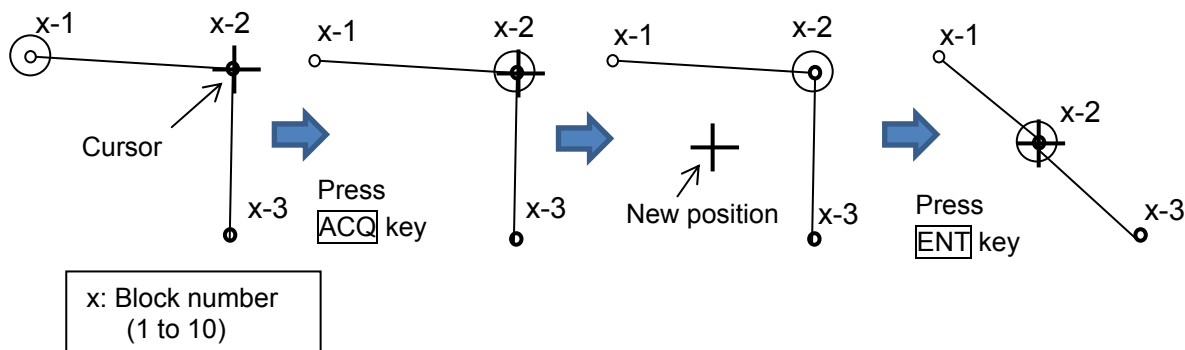

- 6 When move operation is completed, press **MENU** key, numerical marks on the display will disappear, and nav line cross alarm will be activated.

How to add

There are two methods to add nav line cross alarm position.

First method is to use cursor, second is to input latitude/longitude by the menu.

Example: cursor method

- 1 Press **MENU** key to display "Menu".
Select [ALARM] => [NAV LINE CROSS] => [ADD] => [CURSOR] => select [1 to 10] => [GO], and press **ENT** key.
- 2 Move cursor to the nav line cross mark before which you want to add new mark, then change color or delete position data.
- 3 Press **ACQ** key, medium circle mark will appear on the selected mark position, and numerical data information is displayed in the "NAV LINE INFO" window at lower on the display.
- 4 Move cursor to new additional position, then press **ENT** key. New position point will be inserted on the display.

Selected latitude and longitude position data can be changed directly using cursor and **ENT** key via "NAV LINE INFO" window. Line color can be changed directly using cursor via "NAV LINE INFO" window. If you want to delete selected data, move cursor to word "DELETE", then press **ENT** key.

- 5 Repeat operation of clause 2 to 4 mentioned previously.

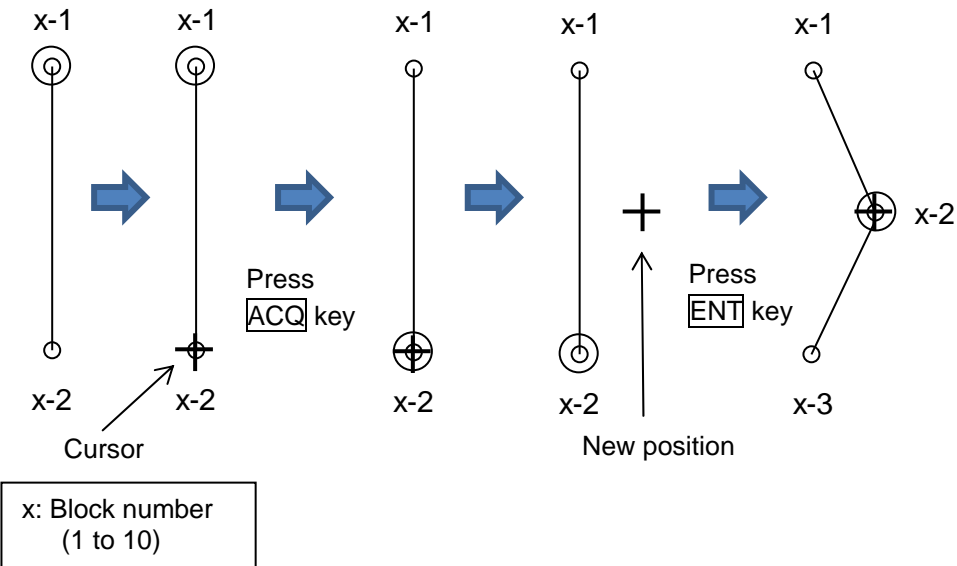

- 6 When add operation is completed, press **MENU** key, numerical marks on the display will disappear, and nav line cross alarm will be activated.

How to delete

There are two methods to delete the data of nav line cross alarm position.

First method is to delete the point that is selected by cursor directly, second is to select the number from the menu.

Example: cursor method

- 1 Press **[MENU]** key to display "Menu".
Select **[ALARM]** => **[NAV LINE CROSS]** => **[DELETE]** => **[CURSOR]** => select [1 to 10] => **[GO]**, and press **[ENT]** key.
- 2 Move cursor to the nav line cross mark which you want to delete.
- 3 Press **[ENT]** key.
Selected nav line cross position data will be deleted.

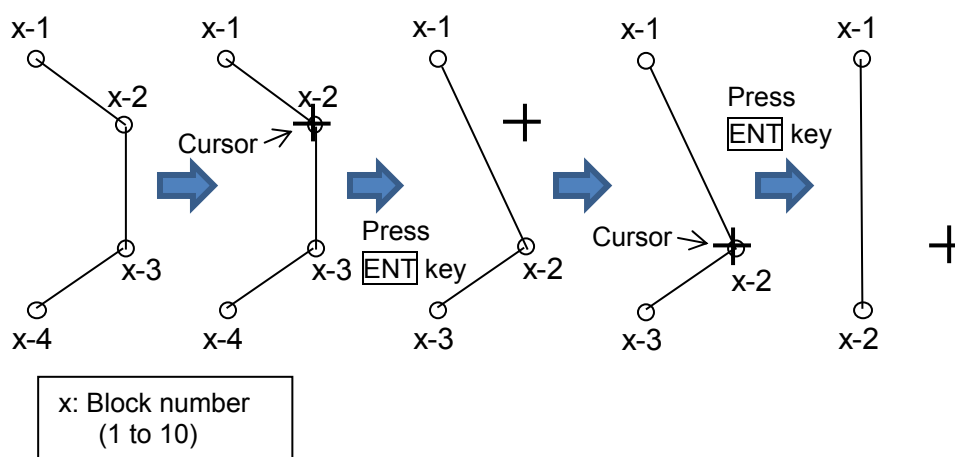

How to clear

The nav line cross alarm data block can be cleared by using menu operation.

- 1 Press **[MENU]** key to display "Menu".
Select **[ALARM]** => **[NAV LINE CROSS]** => **[CLEAR]** => **[BLOCK NUMBER]** => select [1 to 10] => **[GO]**, and press **[ENT]** key.
Selected nav line cross alarm data block will be cleared.

3.5 Alarm on/off (TT and AIS)

This function is to set auto acquisition target (TT and AIS) alarm function on or off which is set by [TARGET] => [AUTO ACQ AREA] menu.

[AUTO ACQ] function [ON] activates the alarm function when TT and/or AIS target enters designated auto acquisition area.

Chapter 4 Target (AIS and TT)

4.1 Common setting

VECTOR REL/TRUE

The course and speed are indicated as vector after tracking is established.

Two types of display mode are available: relative display (REL) and true display (TRUE).

REL: This vector adds the course/speed of a target to the course/speed of own ship.

If the vector is directed towards own ship, possibility of collision exists.

It shows danger of collision at a glance and is useful to avoid collision.

TRUE: This vector shows the course/speed of a target only, regardless of own ship.

- 1 Press **[MENU]** key to display "Menu".

Select **[TARGET]** => **[VECT]**, and press **[ENT]** key after making selection.

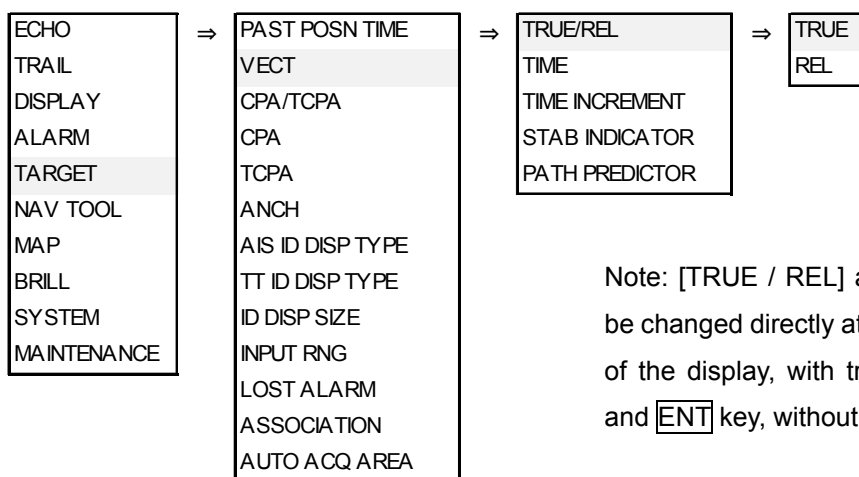

Note: **[TRUE / REL]** and **[TIME]** can be changed directly at the upper right of the display, with trackball/joystick and **[ENT]** key, without using menu.

- 2 In addition, there are **[TIME]**, **[TIME INCREMENT]**, **[STAB INDICATOR]** and **[PATH INDICATOR]** setups.

[TIME]: It designates length of vector by time. When **[TIME]** is specified by 1 min, the vector is displayed to the position that will be reached in 1 min by present target speed.

Selection values: OFF, 30sec, 1min, 3min, 6min, 12min, 30min, 60min

[TIME INCREMENT]: This vector displays the division number of time divider. When the setup value is 2, vector is 1/2 and the parting line is displayed at a half-length location of vector.

Selection values: OFF, 2, 3, 5, 10

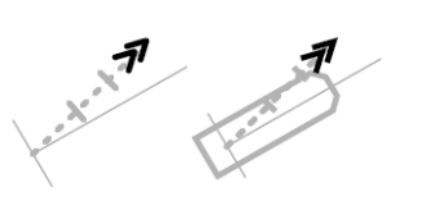
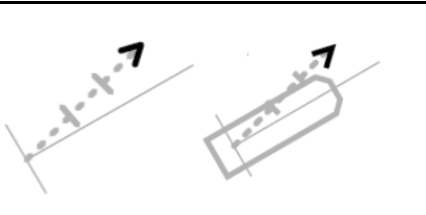

[STAB INDICATOR]: This function is to display the mark of GND or SEA stabilization on the end of own ship vector.

Symbol	Symbol name
	GNG indicator (Double arrowhead)
	SEA indicator (Single arrowhead)

STAB INDICATOR is displayed only when VECTOR is displayed.

STAB INDICATOR is not displayed when PATH PREDICTOR is "on".

[PATH PREDICTOR]: This function is to display a path predictor in place of a velocity vector as a curved line.

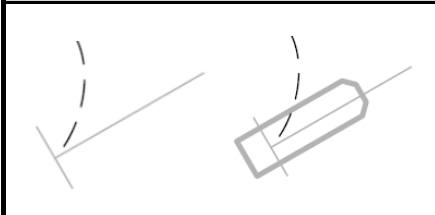
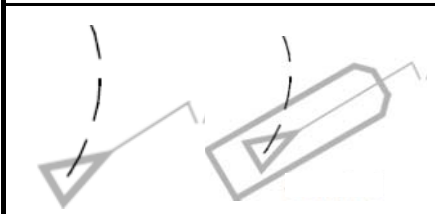
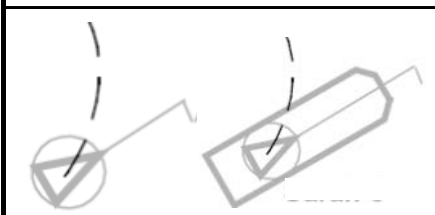
Symbol	Symbol name
	Own ship path predictor
	AIS target predictor
	Associated target path predictor

CPA/TCPA alarm

The menu of “[TARGET] => [CPA/TCPA]” sets the alarm function ON or OFF.

To avoid collision, it sets up LIMIT CPA (closest point of approach) and LIMIT TCPA (time to CPA).

- 1 Press **MENU** key to display “Menu”.
 Select [TARGET] => [CPA], and press **ENT** key after selecting the setup value.
 Setting value: 0.0 to 19.9 NM
 Select [TARGET] => [TCPA], and press **ENT** key after selecting the setup value.
 Setting value: 1.0 to 63.0 min

LOST ALARM

LOST ALARM function of target status area can be changed lost alarm ON or OFF mode of TT (ARPA) and AIS target.

- 1 Press **MENU** key to display “Menu”.
 Select [TARGET] => [LOST ALARM] => select [ON] or [OFF], and press **ENT** key.
- When LOST ALARM is [ON], lost target symbol is displayed on the last reported (known or predicted) target position and a lost target warning is appeared on alarm area display until confirmation operation with **ENT** key.
 - When LOST ALARM is [OFF], lost target symbol is not displayed, and does not appear lost alarm message on alarm area display.

Note: When Sleeping lost of AIS alarm mode sets to OFF, Lost of AIS sleeping target will delete without using confirmation operation.

Refer to 4.2 AIS “AIS alarm [Sleeping lost]”.

Set AIS ID DISP TYPE

ID can be displayed with AIS target.

Set items: NUMBER, NAME, MMSI, IMO and CALLSIGN

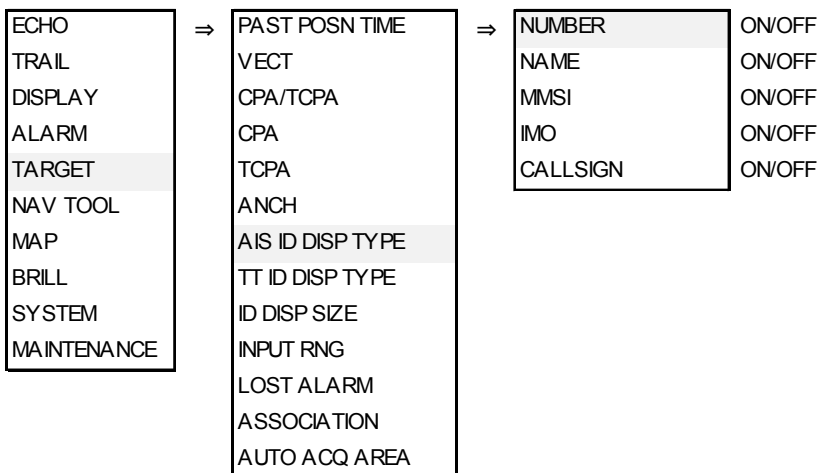

Set TT ID DISP TYPE

ID can be displayed with TT (ARPA) target.

Set items: NUMBER and LABEL

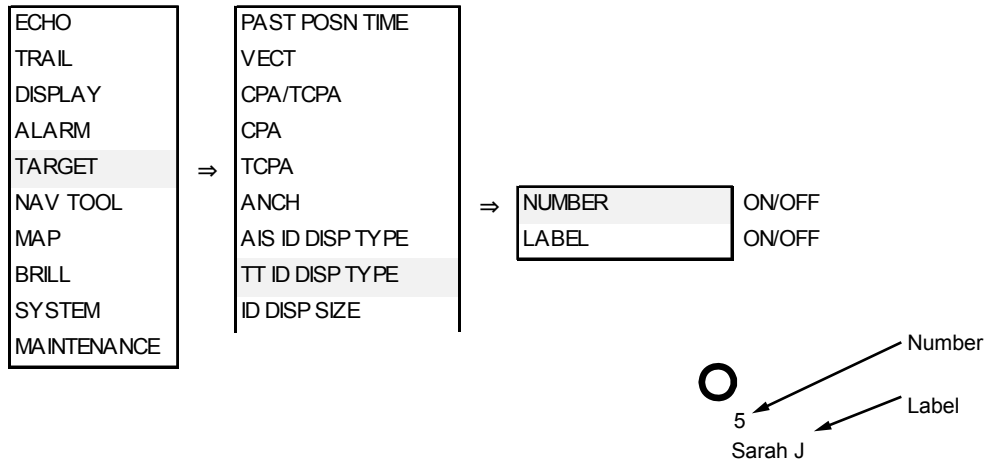

ID can be changed to favorite name.

Maximum 10 letters can be set for the name.

- 1 Press **MENU** key to display "Menu".
Select [TARGET] => [TT] => [EDIT LABEL] => select 10 words, and press **ENT** key.

Set ID DISP SIZE

This menu is used to specify display ID size.

Selection values: X-SMALL, SMALL, MEDIUM, LARGE

Set Input range

This is to set up the operation range of TT (ARPA) and AIS.

It designates the entire operation range of TT (ARPA) and AIS. So, TT (ARPA) and AIS do not function outside of the range.

- 1 Press **MENU** key to display "Menu".
Select [TARGET] => [INPUT RNG], and press **ENT** key after selecting the setup value.
Setting value: 1.0NM to 64.0NM

ASSOCIATION

When an AIS target and a tracked target of TT (ARPA) are the same target, it is automatically associated to a single target.

Select priority of the association with either AIS or TT (ARPA).

If the low-speed ship is associated and displayed with TT priority, then HDG may be unstable. So, the display with AIS priority is recommendable.

1 Press **MENU** key to display "Menu".

Select **[TARGET]** => **[ASSOCIATION]** => **[ASSOCIATION]**, and press **ENT** key after selecting the setup value.

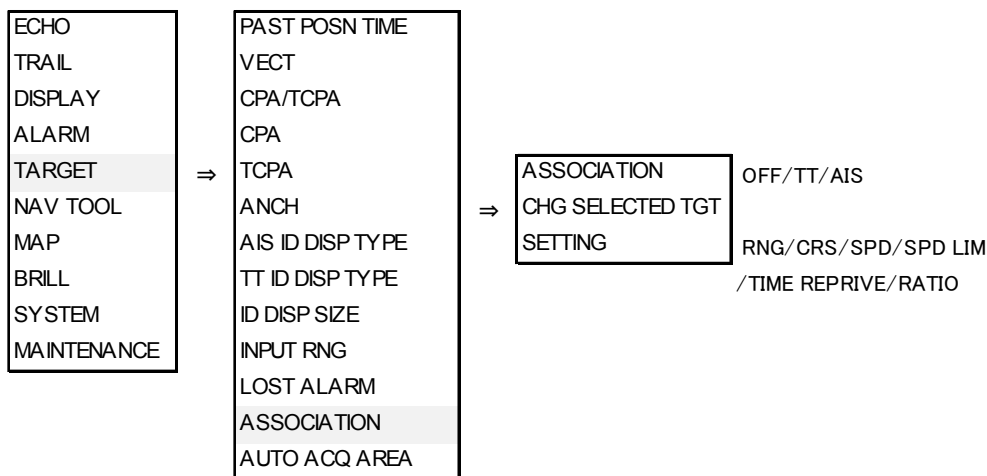

OFF: Association is turned off.

TT: Symbols of both TT (ARPA) and AIS are associated to TT (ARPA). However when the target of AIS is sleeping target it is not associated.

AIS: Symbols of both TT (ARPA) and AIS are associated to AIS. However when the target of AIS is sleeping target it is not associated.

In addition, **[CHG SELECTED TGT]** and **[SETTING]** are provided.

[ASSOCIATION] changes priority of the association of all targets while **[CHG SELECTED TGT]** changes priority of the association for selected target only.

[SETTING] designates conditional items of association among RNG, CRS, SPD, SPD LIM, TIME REPRIEVE and RATIO.

RNG: It designates the range to determine association. (0.001NM to 1.000NM)

CRS: It designates the course to determine association. (10.0° to 60.0°)

SPD: It designates the speed difference to determine association. (1.0kn to 20.0kn)

SPD LIM: It designates the minimum speed to determine association. (1.0kn to 10.0kn)

TIME REPRIEVE: It designates the time to determine association. (1sec to 99sec)

RATIO: It designates the ratio to determine association. (0 to 100)

Automatic acquisition area

AUTO ACQ AREA is function that is used for automatic acquisition of TT or AIS targets that enter area designated in a fan type range.

TT: When an un-tracked target enters, it is automatically acquired and an alarm sounds.

When a tracked target enters, no alarm sounds.

AIS: When a sleeping target enters, it is changed to an active target (activated) and an alarm sounds.

When an active target enters, no alarm sounds.

It takes at least 20 seconds before target is acquired by TT (ARPA).

Take note that the target may not be acquired when the setting area is too narrow or target is moving at high speed.

- 1 Press **MENU** key to display "Menu".
Select [TARGET] => [AUTO ACQ AREA] => [ON], and press **ENT** key.
The color of **EBL1**, **EBL2**, **VRM1** and **VRM2** key's light turn red. (MDC-5500 series only)
- 2 Setup area. (Method using the cursor)
The items to be selected are [BRG REL], [WIDTH], [RNG], and [DEPTH]

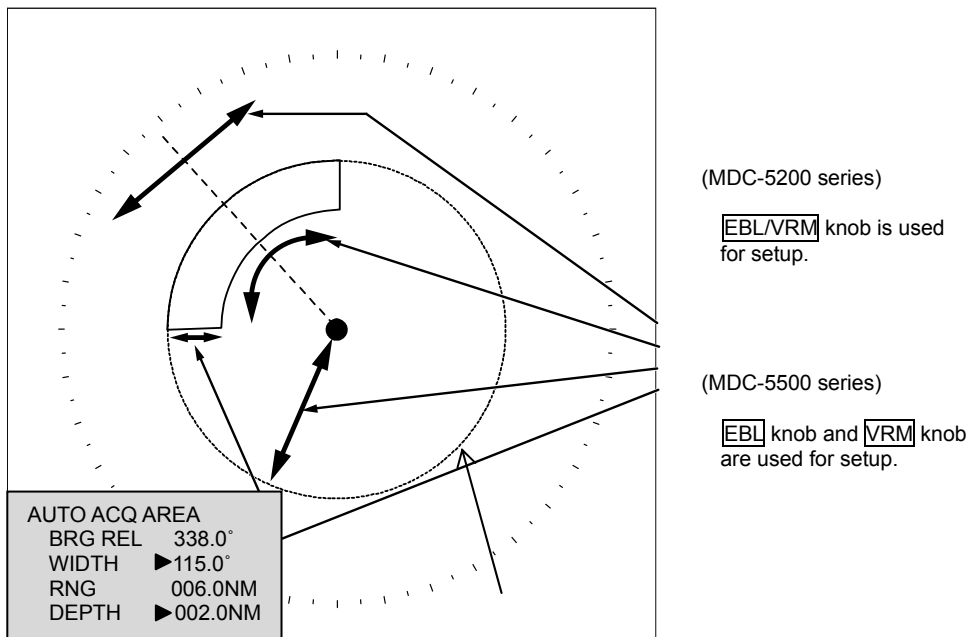

- 3 Press **EBL1** or **EBL2** key, and select an item to be set between [BRG REL] and [WIDTH] by using **EBL/VRM** knob (MDC-5200 series) or **EBL** knob (MDC-5500 series).
In the same way, press **VRM1** or **VRM2** key, and select an item to be set between [RNG] and [DEPTH] by using **EBL/VRM** knob (MDC-5200 series) or **VRM** knob (MDC-5500 series).
The selected item is shown with a ▶ symbol at the left of numerical indication at the auto acquisition area in the menu display.
Note: The changing item by using **EBL/VRM** knob will be displayed with yellow characters.

- When the setting of the automatic acquisition area is completed, then press **ENT** key, AUTO ACQ AREA will be activated.

PAST POSN: Past position

The past position of TT (target tracking) and AIS (activated target) can be displayed.

- Press **MENU** key to display "MENU".
 Select **[TARGET]** => **[PAST POSN TIME]** => and setting value.
 Setting value: OFF, 30sec, 1min, 3min, 6min, 12min, 30min, 60min

[PAST POSN TIME] item designates recording length.

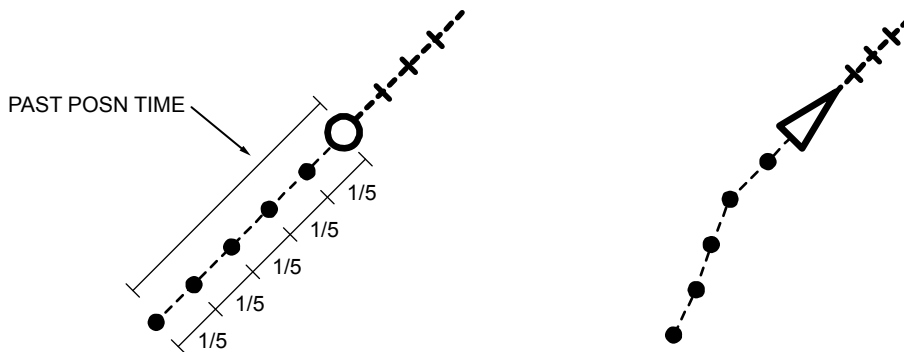

Up to five record points are available.

Note: The past position by its nature records and displays past positions. Immediate display is impossible after the start of TT (ARPA) and after the change from AIS sleep target to active target. In addition, when [PAST POSN TIME] is changed, a past position record is reset (erased). So, immediate display is impossible.

In above case, TT or AIS target number characters in [TGT INFO] message at "ASSISTANT INFO DISP" of the display change to yellow. When "PAST POSN" setting time has passed, character color turns white.

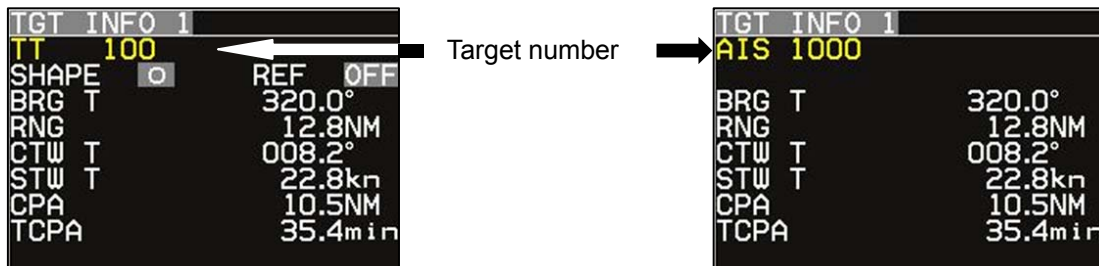

4.2 AIS

- The AIS communicates with other ships via VHF (Very High Frequency) radio by transmitting your ship information and by receiving other ships information.
- Only AIS data with WGS84 datum is accepted.
If AIS data has no datum or if datum is other than WGS84, then the warning of [AIS datum is not WGS84] appears. AIS data is not displayed.
- Capable of displaying up to 1000 other ship symbols/IDs.
- If the displayed targets exceed 951, then caution is displayed at the lower right of the display. AIS target count number at the upper right of the display changes to yellow.
- If the displayed targets exceed 900, then warning is displayed at the lower right of the display. AIS target count number at upper right of the display changes to red.
In that case, change [TARGET] => [INPUT RNG] value and decrease the displayed targets.

Note:

- If the displayed targets exceed 1000, then next coming AIS data cannot be displayed. For the sake of safety, if warning is displayed, then change [INPUT RNG] value immediately and decrease the displayed targets.
- If the own ship information display at upper right of the display is turned orange, then it means that the input sentence is incomplete. So, this function does not work.

If AIS is used in combination with [ASSISTANT INFO DISP], then AIS is effective.

Enable AIS function

This is to enable AIS function.

- 1 Press **MENU** key to display "Menu".
Select [TARGET] => [AIS] => [AIS] => [ON], and press **ENT** key.

Select ID

This is to change the target selected by using [ACTIVE/SLEEP].

- 1 Press **MENU** key to display "Menu".
Select [TARGET] => [AIS] => [SELECT ID], and press **ENT** key after selecting the setup value.
Selection values: 101 to 1100

ACTIVE/SLEEP

This is to change ACTIVE/SLEEP of the target selected by [SELECT ID] function.

The change of ACTIVE/SLEEP can be executed also by using trackball/joystick, moving a cursor to the desired target, then press **ENT** key.

Ship outline

Ship outline function is displayed only when OUTLINE is included in the target information received by AIS.

Ship outline is not displayed if it is less than 6mm in size of the display, and it is not displayed when own ship outline is OFF.

(Refer to 4.2 AIS “Types of AIS target symbol”)

(Refer to [NAV TOOL] => [SHIP OUTLINE] => [SHIP OUTLINE] and [OS PROFILE])

- 1 Press **MENU** key to display “Menu”.
Select [TARGET] => [AIS] => [SHIP OUTLINE] => [ON], and press **ENT** key.
Selection values: OFF, ON

HDG line

This is displayed only when HDG LINE is included in the target information received by AIS.

(Refer to 4.2 AIS “Types of AIS target symbol”)

- 1 Press **MENU** key to display “Menu”.
Select [TARGET] => [AIS] => [HDG LINE] => [ON], and press **ENT** key.
Selection values: OFF, ON

Turn indicator

This is displayed only when HDG LINE is included in the target information received by AIS.

(Refer to 4.2 AIS “Types of AIS target symbol”)

- 1 Press **MENU** key to display “Menu”.
Select [TARGET] => [AIS] => [TURN INDICATOR] => [ON], and press **ENT** key.
Selection values: OFF, ON

OS display

This is to turn own ship AIS symbol ON or OFF.

- 1 Press **MENU** key to display “Menu”.
Select [TARGET] => [AIS] => [OS DISP] => [ON], and press **ENT** key.
Selection values: OFF, ON

OS MMSI

This menu is where user can enter MMSI number of own ship.

MMSI number is necessary to be able to receive message for own ship.

- 1 Press **MENU** key to display “Menu”.
Select [TARGET] => [AIS] => [OS MMSI] => set numbers, and press **ENT** key.
Setting value: 0 to 1073741824

AIS filter

When there are many AIS targets, the display may become unclear. In that case, by setting AIS FILTER, it is possible to hide unnecessary sleeping targets or to display the necessary targets only, and the clear view of the target can be achieved.

Note: The filter is absolutely used to limit display. When input is to be limited, [INPUT RNG] shall be operated.

- 1 Press **MENU** key to display "Menu".
Select [TARGET] => [AIS] => [AIS FILTER], and press **ENT** key after selecting the setup value.
Selection values:

CLASS A:	OFF, ON	
CLASS B:	OFF, ON	
RNG:	0.0 to 64.0NM	
SPD:	0.0 to 100.0kn	
CPA/TCPA:	OFF, ON	
MOORED:	OFF, ON	
AT ANCHOR:	OFF, ON	
AGROUND:	OFF, ON	
NUC:	OFF, ON	
GUARD ZONE:	OFF, ON	Exclude from RNG filter.
ECHO ALARM:	OFF, ON	Exclude from RNG filter.

AtoN ON/OFF

AtoN (Aids to Navigation) is included in the received AIS information.

Select [ON] (display of AtoN) or [OFF] (no display of AtoN).

- 1 Press **MENU** key to display "Menu".
Select [TARGET] => [AIS] => [ATON] => select [OFF] or [ON], and press **ENT** key.

AIS alarm [Sleeping lost]

When sleeping target disappears, AIS alarm will come on.

- 1 Press **MENU** key to display "Menu".

Select [TARGET] => [AIS] => [AIS ALARM] => [SLEEPING LOST] => [ON], and press **ENT** key.

Selection values: OFF, ON

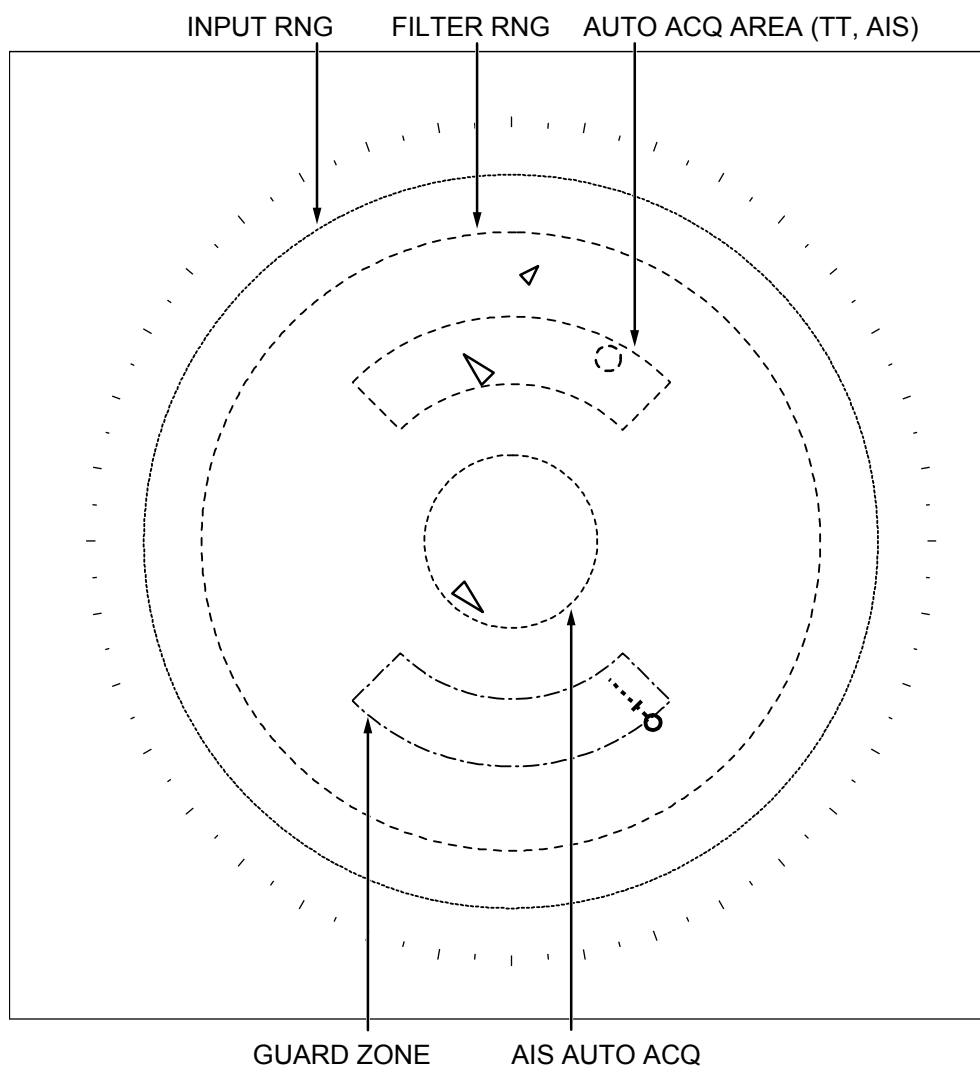





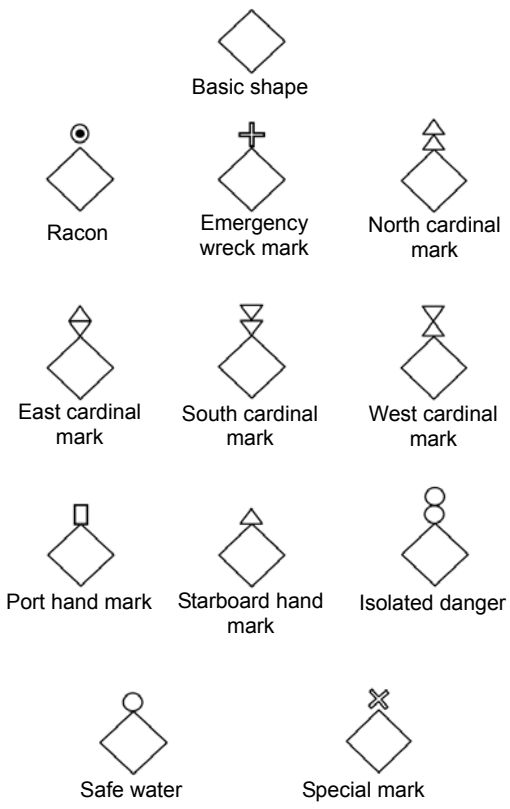
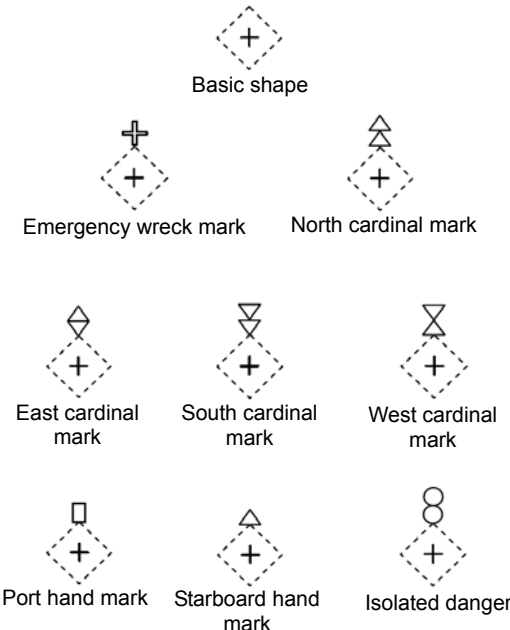

Types of AIS target symbol

The following symbols are overlapped on target.

Symbol	Symbol name
	Sleeping target
	Sleeping target without HDG.
	Sleeping target with neither reported HDG nor COG.
*	Activated target
*	Activated target without HDG.
*	Activated target with neither reported HDG nor COG.
*	Activated target - true scaled outlines
*	Activated target - dangerous targets
*	Activated target without HDG.
*	Activated target with neither reported HDG nor COG.
*	Activated target with heading lines
*	Activated target with turn indicators

 <p>Basic shape</p> <p>Racon</p> <p>Emergency wreck mark</p> <p>North cardinal mark</p> <p>East cardinal mark</p> <p>South cardinal mark</p> <p>West cardinal mark</p> <p>Port hand mark</p> <p>Starboard hand mark</p> <p>Isolated danger</p> <p>Safe water</p> <p>Special mark</p> <p>(IALA dictionary, topmarks)</p> <p>Off Posn</p> <p>Unlit</p> <p>Racon err</p> <p>Off position</p> <p>Lights failure</p> <p>Racon failure</p>	<p>Physical AIS AtoN</p>
 <p>Basic shape</p> <p>Emergency wreck mark</p> <p>North cardinal mark</p> <p>East cardinal mark</p> <p>South cardinal mark</p> <p>West cardinal mark</p> <p>Port hand mark</p> <p>Starboard hand mark</p> <p>Isolated danger</p>	<p>Virtual AIS AtoN</p>

 <p>Safe water</p>  <p>Special mark</p> <p>(IALA dictionary, topmarks)</p>  <p>Missing</p> <p>Intended location of missing AtoN</p>	
	<p>AIS –SART (AIS Search And Rescue Transponder)</p>
	<p>BASE</p>
	<p>AIS SAR aircraft</p>
	<p>AIS SAR vessel</p>

* ID can be displayed with Activated target.

4.3 TT (ARPA)

It is an effective mean for collision avoidance by generating vectors on tracked targets.

It is an effective means for collision avoidance to set up CPA/TCPA.

If AIS information is available with tracked targets, association increases tracking accuracy.

Limitations of the TT function

There are the following limitations on use of the target acquisition and tracked target of TT (ARPA) functions.

Note:

- If multiple targets approach each other, this may cause the system to regard them as one target and thus to swap them or loss part of them. Such swapping or loss of targets may also occur if the picture of the target being tracked is affected by rain/snow clutter returns or sea clutter returns or moves very close to land.
- Intensity of echoes and the TT function have a correlation ship, and thus the target will be lost if no echoes and detected during six scans in succession. If a lost target exists, therefore, radar gain must be increased to support detection of the target. If radar gain is increased too significantly, sea clutter returns or other noise may be erroneously detected and tracked as a target, and resultingly, a false alarm may be issued.
- To execute accurate tracking, it becomes necessary first to appropriately adjust the **GAIN**, **SEA** and **RAIN** knobs of the radar so that the target to be acquired and tracked id clearly displayed on the radar display. Inappropriate settings of these adjustments reduce the reliability / accuracy of automatic tracking.

Enable TT function

This is to enable TT function.

- 1 Press **MENU** key to display “menu”.
Select [TARGET] => [TT] => [TT] => [ON], and press **ENT** key.

Note:

- Pressing **ACQ** key in [OFF] state automatically turns to [ON] state.
- TT function does not work due to incompleteness of input sentence.
- TT (ARPA) is effective by using TT in combination with [ASSISTANT INFO DISP].

Manual acquisition

- 1 Move cursor to a target to be acquired, and then press **ACQ** key.

A broken circle symbol is displayed at the cursor location, and acquisition starts.

About 30sec. from 1min. later, a broken circle symbol turn into a thick solid line, displayed vector of target's motion trend and TT ID number (if selected), and displayed within 3min. the target's prediction motion.

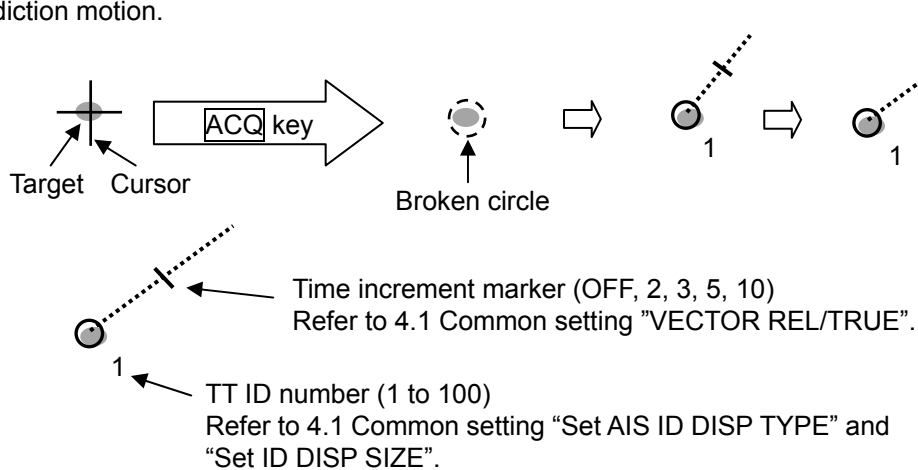

Delete TT target

There are two methods to delete TT target.

First method is to use menu operation, second is to use cursor operation.

Menu operation

This is to delete the TT target selected [SELECT ID] and [DELETE] function.

- 1** Press **MENU** key to display "Menu".
Select [TARGET] => [TT] => [SELECT ID] => select ID number, and press **ENT** key.
Selection values: 1 to 100
- 2** Select [DELETE] => and press **ENT** key.

Cursor operation







- 1** Move cursor to a TT (ARPA) target to be deleted, keep **OFF** key pressed, and then press **ACQ** key.

Delete all TT targets

- 1** Press **MENU** key to display "Menu".
Select [TARGET] => [TT] => [ALL DELETE], and press **ENT** key.
All TT targets acquisitions are deleted.

Types of tracked target symbol

The following symbols are overlaid on target.

Symbol	Symbol name
	Radar target in acquisition state
*  Blink in 0.5 sec. interval	Radar target in acquisition state - Automatic acquisition (Red color)
** 	Tracked radar target
** 	Tracked radar target (Displayed at indicating numerical value.)
**  Blink in 0.5 sec. interval	Tracked radar targets - dangerous target (Red color)
**  Blink in 0.5 sec. interval	Lost target (Red color)

* Pressing OFF key to acknowledge changes of target symbol to normal color and stop blinking.

** ID can be displayed in Tracked target.

*** Alarm display and alarm sound disappear by pressing OFF key to acknowledge, while color remains red until the target leaves outside of setting range or tracking is stopped.

**** The lost target display disappears automatically when OFF key is pressed to acknowledge or when 10 seconds have passed.

Chapter 5 Nav tool

5.1 Guard line

Guard line function is a function that displays parallel lines to the heading on both side of own ship.

Distance to guard line from own ship can be set from 0 to 10000m (left and right side independently).

- 1 Press MENU key to display "Menu".
Select [NAV TOOL] => [GUARD LINE] => [ON], and press **ENT** key.
- 2 Select [LEFT] => set left side distance 0 to 10000m, and press **ENT** key.
- 3 Select [RIGHT] => set right side distance 0 to 10000m, and press **ENT** key.

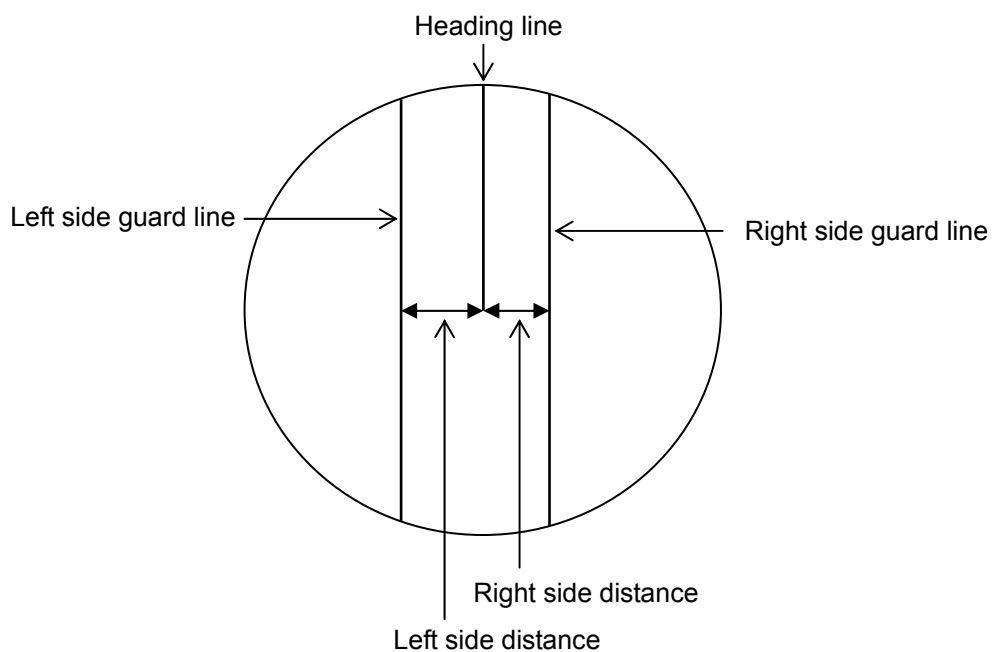

5.2 HL blink

HL BLINK function lets HL marker display blinks every antenna rotation. It is effective to confirm that there is no small targets right under the HL marker.

- 1 Press **MENU** key to display "Menu".
Select **[NAV TOOL]** => **[HL BLINK]** => **[ON]**, and press **ENT** key.

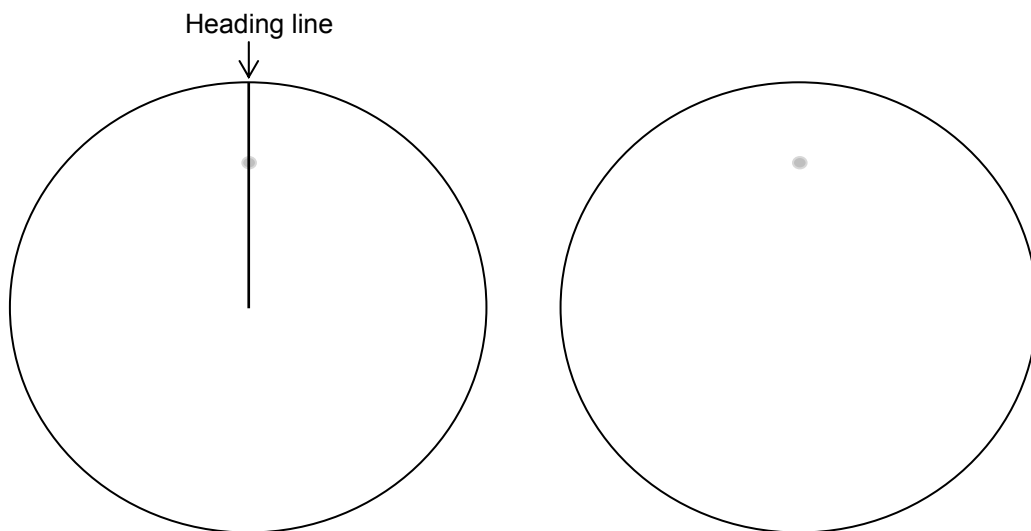

5.3 Stern line

STERN LINE is to set up the display of dotted line extended from reference position to bearing scale toward stern direction.

- 1 Press **MENU** key to display "Menu".
Select **[NAV TOOL]** => **[STERN LINE]** => **[ON]**, and press **ENT** key.

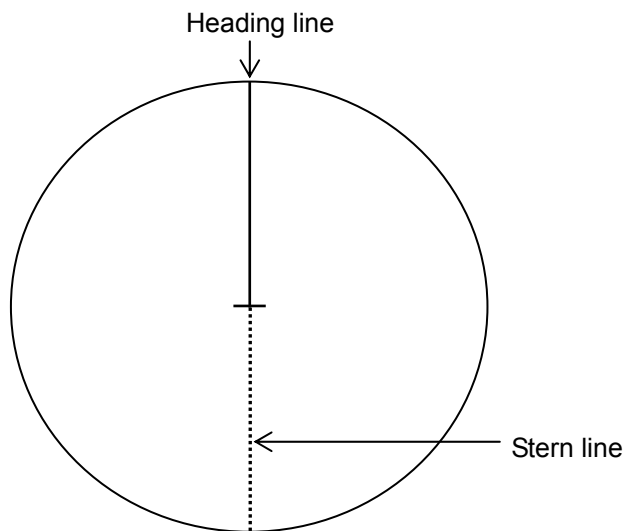

5.4 Barge icon

This radar is equipped with a barge icon feature that is very helpful for river operation where user can set up the size dimensions of the tow and be able to display it on the display.

- 1 Press **MENU** key to display "Menu".
Select [NAV TOOL] => [BARGE ICON] => [BARGE ICON] => [ON], and press **ENT** key.
- 2 Select and set [POSITION], [LENGTH], [WIDTH], [LINE NO.], [ROW NO.], [OFFSET]
 POSITION: FWD, AFT
 LENGTH: 0m to 511m
 WIDTH: 0m to 511m
 LINE NO.: 1 to 10
 ROW NO.: 1 to 10
 OFFSET: 0m to 511m

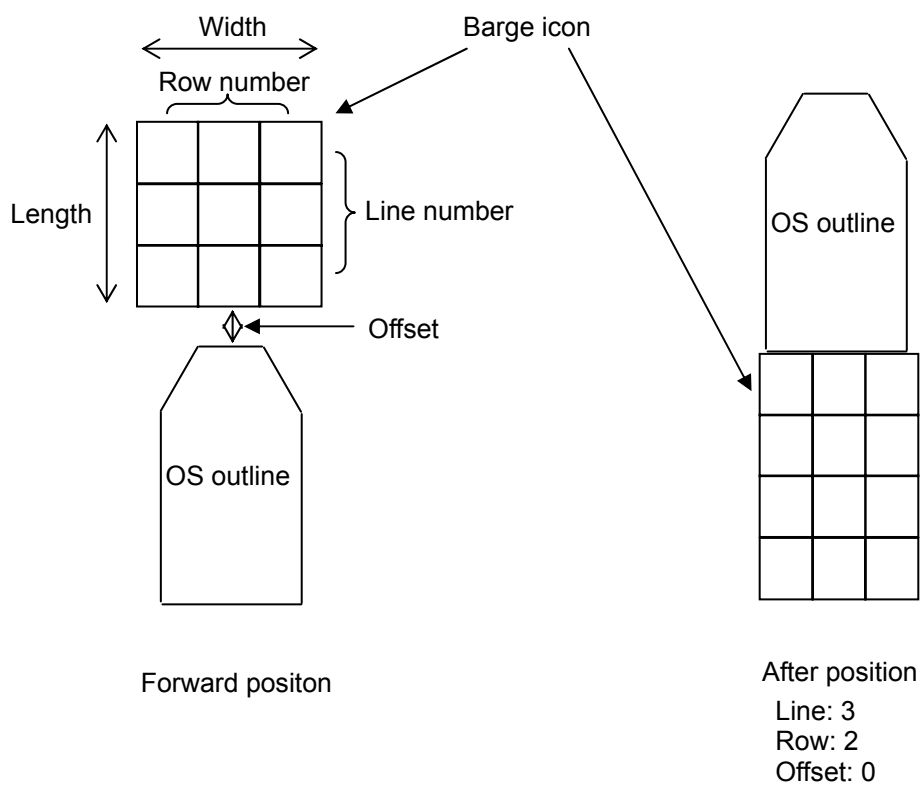

- This page intentionally left blank.-

Chapter 6 Map operation

6.1 MAP function display ON or OFF

This is to turn ON/OFF the entire MAP function.

- 1 Press **MENU** key to display "Menu".
Select [MAP] => [MAP DISP] => [ON], and press **ENT** key.

It is not displayed as well as HL while **OFF** key is pressed.

This operation links the functions, COAST LINE, NAV LINE, ROUTE, EVENT MKR and AREA.

6.2 OWN SHIP PAST TRACK

This is to set up OWN SHIP PAST TRACK display, function ON or OFF, clear operation, color setting, plot style, plot interval and maximum plot numbers.

- 1 Press **MENU** key to display "Menu".
Select [MAP] => [OWN TRACK] => [ON] and press **ENT** key.

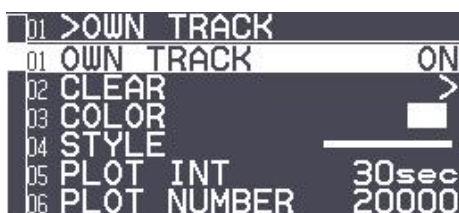

- 2 Select [COLOR] => select color from eight colors => press **ENT** key.
PAST TRACK will turn selected color.
- 3 Select [STYLE] => select past track line style* => press **ENT** key.

*Line style:



- 4 Select [PLOT INT] => and press **ENT** key after selecting the set up value.
Selection values: 1sec, 2sec, 5sec, 10sec, 30sec, 1min, 3min
- 5 Select [PLOT NUMBER] => and press **ENT** key after selecting the set up value.
Selection values: 1000, 2000, 4000, 5000, 7000, 10000, 20000

How to Clear OWN SHIP PAST TRACK

- 1 Press **MENU** key to display "Menu".
Select [MAP] => [OWN TRACK] => [CLEAR] => [GO], and press **ENT** key.
All OWN SHIP PAST TRACK disappears, recording and display will restart.

6.3 Target track past position display

This is to set up TT past track position display, display ON or OFF, clear operation, color setting, select track style, plot interval and maximum plot numbers.

- 1 Press **MENU** key to display "Menu".
Select [MAP] => [TARGET TRACK] =>
- 2 Select [TARGET TRACK] => move trackball/joystick to right, select [1 to 100], and press **ENT** key.
- 3 Select [DISPLAY] => [ON], and press **ENT** key.
- 4 Select [CLEAR] => [GO], and press **ENT** key.
The past track of chosen TT will be deleted.
- 5 Select [COLOR] => select color from eight colors => press **ENT** key.
TT past track will turn selected color.
- 6 Select [STYLE] => select style* => press **ENT** key.
*Line style:
 
- 7 Select [PLOT INT] => and press **ENT** key after selecting the set up value.
Selection values: OFF, 2sec, 15sec, 30sec, 1min, 3min, 5min
- 8 Select [PLOT NUMBER] => and press **ENT** key after selecting the set up value.
Selection values: 50, 100, 200, 500, 1000

Target track start

- 1 Move cursor to an AIS target or TT (ARPA) target to display track, keep **ENT** key pressed, and then press **ACQ** key.

Target track finish

- 1 Move cursor to an AIS target or TT (ARPA) target to track off, and then press **OFF** key.

6.4 COAST LINE

This function is to let user generate up to 10 coast lines with up to 100 points each to mark important areas of navigation, such as danger zone areas or navigation channels etc. Coast line can be setup by inputting Lat/Lon information for each point or using cursor and **ENT** key.

It is displayed one by one or all.

- 1 Press **MENU** key to display "Menu".
 Select [MAP] => [COAST LINE] =>
 COAST LINE: Select the number of the coast line to display. (ALL, 1 to 10, OFF)
 ALL: Display all ten coast line.
 1 to 10: Display the coast line of selected number.
 OFF: Don't display coast line.
 EDIT: Create coast line. (CURSOR, BLOCK NUMBER)
 MOVE: Change the position. (CURSOR, BLOCK NUMBER)
 ADD: Insert a position data. (CURSOR, BLOCK NUMBER)
 DELETE: Delete a position data. (CURSOR, BLOCK NUMBER)
 CLEAR: Clear a selected block number coast line data.

How to edit

(1) CURSOR OPERATION

- 1 Press **MENU** key to display "Menu".
 Select [MAP] => [COAST LINE] => [EDIT] => [CURSOR] => select [1 to 10] => [GO] and press **ENT** key.
- 2 Move cursor to first input position, then press **ENT** key. No.1 mark is displayed on the display and numerical data is shown at "COAST LINE INFO" window.

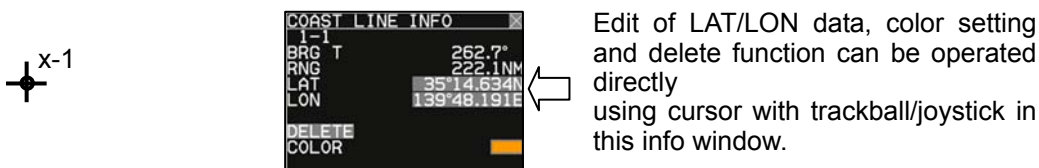

- 3 Move cursor to second input position, then press **ENT** key. No.2 mark is displayed, and a line is generated from No.1 to No.2.



- 4** Move cursor to third input position, then press **ENT** key. No.3 mark is displayed, and a line is generated from No.2 to No.3.
 You can input up to 100 point. When input is completed, press **MENU** key. Mark number will disappear.

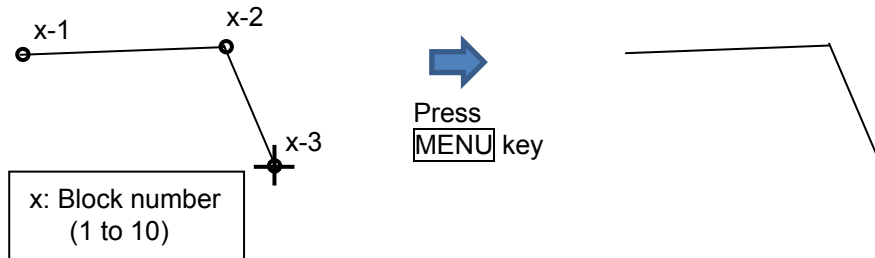

- 5** Refer to 3.4 Nav line cross “How to edit” for the procedures to make plural divided coast line in the memory of same block number.

(2) BLOCK NUMBER OPERATION

- 1** Press **MENU** key to display “Menu”.
 Select **[MAP]** => **[COAST LINE]** => **[EDIT]** => **[BLOCK NUMBER]** => [select number 1 to 10] =>
 Following input menu is displayed.

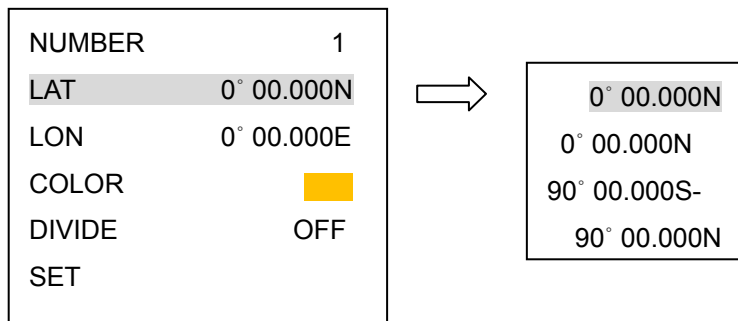

- 2** Select **[LAT]** => Latitude data set screen is displayed.
 Set LAT data with up, down, right and left roll action of trackball/joystick, and press **ENT** key.
- 3** Select **[LON]** => Longitude data set screen is displayed.
 Set LON data with up, down, right and left roll action of trackball/joystick, and press **ENT** key.
- 4** Select **[COLOR]** => Eight colors box is displayed.
 Select color with up and down roll action of trackball/joystick, and press **ENT** key.
- 5** Select **[DIVIDE]** => **[ON]** or **[OFF]**, and press **ENT** key.
[DIVIDE] => **[ON]** means that it is not connected coast line to the next number data.

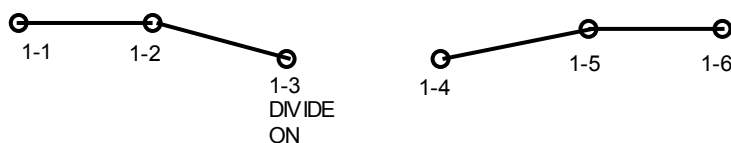

- 6** Select **[SET]**, and press **ENT** key to save input data.

How to move

(1) CURSOR OPERATION

- 1 Press **[MENU]** key to display "Menu".

Select **[MAP]** => **[COAST LINE]** => **[MOVE]** => **[CURSOR]** => select [1 to 10] => **[GO]**, and press **[ENT]** key. Numerical number is displayed each points of coast line.

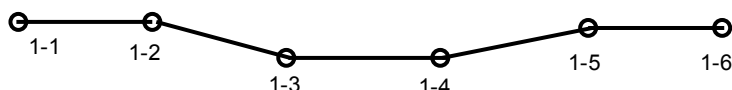

- 2 Move cursor on editing and moving cursor data.

Press **[ACQ]** key. Circle mark will be displayed on the selected coast line and numerical data is shown at coast line info area.

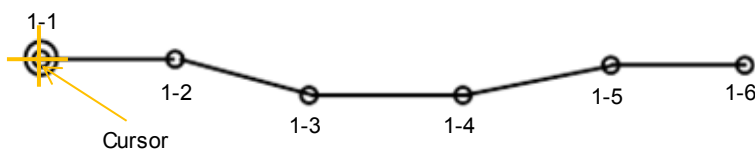

- 3 Move cursor to new position, then press **[ENT]** key.

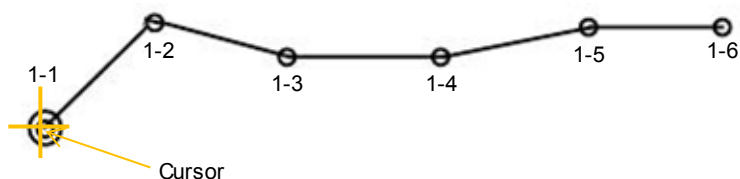

- 4 Press **[MENU]** key to exit MOVE operation.

(2) BLOCK NUMBER OPERATION

- 1 Press **[MENU]** key to display "Menu".

Select **[MAP]** => **[COAST LINE]** => **[MOVE]** => **[BLOCK NUMBER]** => select [1 to 10] =>

Following input menu is displayed.

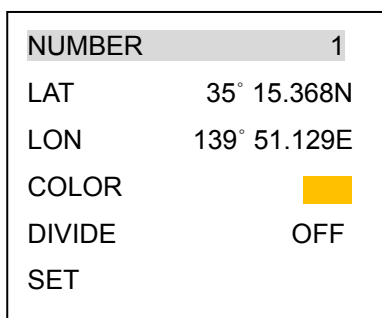

- 2 Select **[NUMBER]** => NUMBER data screen is displayed. => select [1 to 100] =>

Press **[ENT]** key. Selected number's numerical data is shown.

- 3 Edit data of LAT, LON, COLOR and DIVIDE.

- 4 Select **[SET]**, and press **[ENT]** key to save input data.

How to add

(1) CURSOR OPERATION

- 1 Press **MENU** key to display "Menu".
 Select **[MAP]** => **[COAST LINE]** => **[ADD]** => **[CURSOR]** => select [1 to 10] => **[GO]**, and press **ENT** key. Numerical number is displayed each points of coast line.

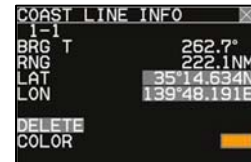
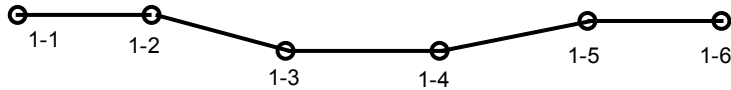

- 2 Move cursor on position that new data is added in just before it.
 Press **ACQ** key. Circle mark will be displayed on the selected

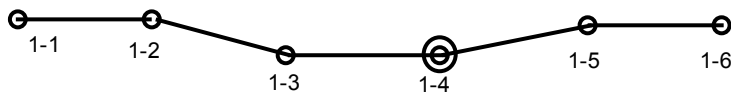

- 3 Move cursor to the position that new data will be added, then press **ENT** key.

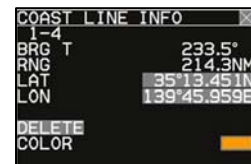
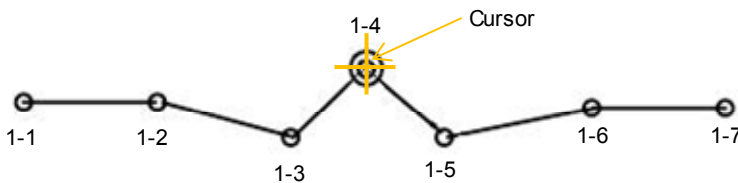

- 4 Press **MENU** key to exit ADD operation.

(2) BLOCK NUMBER OPERATION

- 1 Press **MENU** key to display "Menu".
 Select **[MAP]** => **[COAST LINE]** => **[ADD]** => **[BLOCK NUMBER]** => select [1 to 10] =>
 Following input menu is displayed.

NUMBER	4
LAT	35° 15.368N
LON	139° 51.129E
COLOR	
DIVIDE	OFF
SET	

- 2 Select **[NUMBER]** => NUMBER data screen is displayed. => select [1 to 100] =>
 Press **ENT** key. Selected number's numerical data is shown.
- 3 Edit data of LAT, LON, COLOR and DIVIDE.
- 4 Select **[SET]**, and press **ENT** key to save input data. New data is added as same as cursor operation.

How to delete

(1) CURSOR OPERATION

- 1 Press **[MENU]** key to display "Menu".

Select **[MAP]** => **[COAST LINE]** => **[DELETE]** => **[CURSOR]** => select [1 to 10] => **[GO]**, and press **[ENT]** key. Numerical number is displayed each points of coast line.

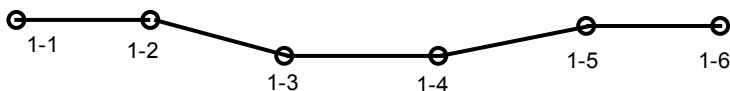

- 2 Move cursor on the position deleting.

Press **[ENT]** key. Selected coast line data will be deleted.

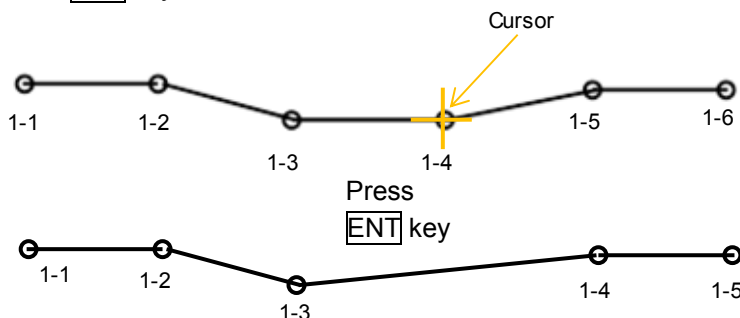

(2) BLOCK NUMBER OPERATION

- 1 Press **[MENU]** key to display "Menu".

Select **[MAP]** => **[COAST LINE]** => **[DELETE]** => **[BLOCK NUMBER]** => select [1 to 10] =>

Following delete menu is displayed.

NUMBER	4
LAT	35° 15.368N
LON	139° 51.129E
SET	

- 2 Select **[NUMBER]** => NUMBER data screen is displayed. => select [1 to 100] =>

Press **[ENT]** key. Selected number's numerical data is shown.

- 3 Select **[SET]**, and press **[ENT]** key to delete selected data.

How to clear

All data of selected block number are cleared.

- 1 Press **[MENU]** key to display "Menu".

Select **[MAP]** => **[COAST LINE]** => **[CLEAR]** => **[BLOCK NUMBER]** => select [1 to 10] => select **[GO]**, and press **[ENT]** key.

6.5 NAV LINE

NAV LINE is a function to display Navigation line by inputting Lat/Lon information for each point or using a cursor and **ENT** key to input the points, user can set 10 lines up to 100 points each.

“NAV LINE” generated in this section can also be used in the alarm function for “NAV LINE CROSS” alarm.

Refer to 3.4 Nav line cross.

- 1 Press **MENU** key to display “Menu”.
Select **[MAP]** => **[NAV LINE]** =>
NAV LINE: Select the number of the nav line to display. (ALL, 1 to 10, OFF)
EDIT: Make nav line. (CURSOR, BLOCK NUMBER)
MOVE: Revise the position of the nav line. (CURSOR, BLOCK NUMBER)
ADD: Add a point data in a nav line. (CURSOR, BLOCK NUMBER)
DELETE: Delete a point data in a nav line. (CURSOR, BLOCK NUMBER)
CLEAR: Clear selected block number nav line data.

NAV LINE operation is same as 3.4 Nav line cross and 6.4 COAST LINE operation.

6.6 ROUTE

The ROUTE function is for display purposes only, user can setup ROUTE on radar display for visual navigation aid. ROUTE can be setup using cursor and **ENT** key or by inputting Lat/Lon information for each point. User can add 10 routes with up to 100 points each by using below procedure.

Note: If WPT ID DISP in MAP menu is set to "OFF" then route waypoint name information will not be displayed, and if set to "ON" all waypoints on the route will have name information displayed next to them.

- 1 Press **MENU** key to display "Menu".

Select [MAP] => [ROUTE] =>

ROUTE: Select the number of the route to display. (ALL, 1 to 10, OFF)

EDIT: Make route. (CURSOR, BLOCK NUMBER)

MOVE: Revise route position. (CURSOR, BLOCK NUMBER)

ADD: Add a point to a route. (CURSOR, BLOCK NUMBER)

DELETE: Delete a point from a route. (CURSOR, BLOCK NUMBER)

CLEAR: Clear selected block number route.

ROUTE operation is same as COAST LINE operation.

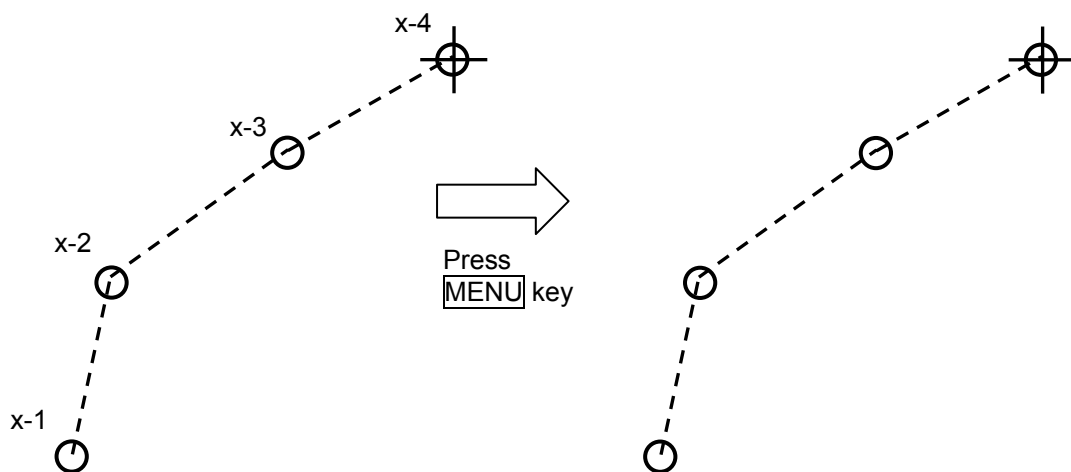

6.7 EVENT MKR

EVENT MKR function displays various marks on the designated place, and can utilize it for sign, such as a destination, a fishery and a caution area. EVENT MKR set can be done by input of Lat/Lon information or by cursor and **ENT** key.

There are 10 blocks that can store 100 marks in each block.

Below procedure is to operate [EVENT MKR] menu.

- 1 Press **MENU** key to display "Menu".
 Select [MAP] => [EVENT MKR] =>
 EVENT MKR: Select the number of the route to display. (ALL, 1 to 10, OFF)
 EDIT: Input event mark. (CURSOR, BLOCK NUMBER)
 MOVE: Revise position of an event mark. (CURSOR, BLOCK NUMBER)
 ADD: Add an event mark. (CURSOR, BLOCK NUMBER)
 DELETE: Function to delete event mark using cursor and **ENT** key or BLOCK NUMBER.
 CLEAR: Clear all event marks in a given memory block.

User can designate function key such as [F1] - [F6] to [EVENT CURSOR] or [EVENT OWN] for quick shortcut to input [EVENT MKR].

Refer to 2.21 Function key usage.

When set [EVENT MKR] by using function key operation, this radar can output Lat/Lon data of EVENT MKR to external device.

It is necessary to set the output port to output [EVENT MKR] data to external device, following [MAINTENANCE] menu must be set.

- 1 Press **MENU** key to display "Menu".
 Select [MAINTENANCE] => [I/O] => [OUTPUT] => [TLL OUT] => [MARK], and press **ENT** key.
- 2 Select [MAINTENANCE] => [I/O] => [OUTPUT] =>
 Select [OUTPUT PORT from J3, J5, J6, OP1 and OP2] that is connected to external device.
- 3 Select [TLL] => set time to [0.1 to 10.0 sec (except 0.0 sec)], and press **ENT** key.

When pressing function key (EVENT CURSOR or EVENT OWN), this radar outputs the Lat/Lon data of EVENT by \$RATLL sentence.

6.8 AREA

Area function is for visual navigation where user can input points connected by a line to help with navigation. There are 10 memory blocks for area that can hold up to 100 points each. This function is valid with a minimum input of 3 points which will be connected with a line.

It is possible to use AREA to set alarm for targets entering or leaving the area.

Refer to 3.2 Map area alarm.

- 1 Press **MENU** key to display "Menu".
Select [MAP] => [AREA] =>
AREA: Select the block number to display. (ALL, 1 to 10, OFF)
EDIT: To create new area. (CURSOR, BLOCK NUMBER)
MOVE: Revise the position of points in area. (CURSOR, BLOCK NUMBER)
ADD: Add a point to any given position in an area line. (CURSOR, BLOCK NUMBER)
DELETE: Delete a point data in area. (CURSOR, BLOCK NUMBER)
CLEAR: Clear selected block number area data

AREA operation is same as 3.2 Map area alarm operation.

6.9 MONITORED ROUTE

This function when activated can display ROUTE information from external device such as chart plotter or GPS navigator.

RTE + WPL sentences are required from external device to display ROUTE information.

RMB or BWC sentence when inputted from external device will display waypoint information only.

If [RTE + WPL] and [RMB] or [BWC] are inputted in the radar, the ROUTE [RTE + WPL] information takes priority over [RMB] or [BWC] waypoint information.

Route is displayed by dotted line in orange color.

- 1 Press **MENU** key to display "Menu".
Select [MAP] => [MONITORED ROUTE] => [ON], and press **ENT** key.

6.10 WPT ID DISP

This function when activated can display WPT name information from external device such as chart plotter or GPS navigator. This applies to all waypoints from WPT and also ROUTE waypoints. When [WPT ID DISP] turned on, ID information will be displayed next to waypoints and when turned off only waypoints without ID information will be displayed.

- 1 Press **MENU** key to display "Menu".
Select [MAP] => [WPT ID DISP] => [ON], and press **ENT** key.

6.11 TARGET TRACK ID

When tracking a target and past target track is activated, each track will have a label number associated with it. TARGET TRACK ID and the numbers will disappear or reappear with turning this function "on" or "off".

- 1 Press **MENU** key to display "Menu".
Select [MAP] => [TARGET TRACK ID] => [ON], and press **ENT** key.

6.12 DATUM

Local geodetic datum and datum offsets from a reference datum. This is used to define the datum to which a position location and geographic locations are referenced. Latitude, Longitude and altitude offsets from the reference datum, and the selection of the referenced datum is provided in following menu.

This is to set up DATUM code.

- 1 Press **[MENU]** key to display "Menu".

Select [MAP] => [DATUM] => select [W84], [W72], [S85], [P90], [999], => and press **[ENT]** key.

[999] is a user datum. In some special cases and or areas specific datum should be entered therefore please use user datum and edit it for that specific datum. User datum can be setup by following "EDIT USER DATUM" menu.

6.13 EDIT USER DATUM

In case that user specific datum needs to be entered such as TOY for Tokyo, then use below procedure to set the name.

- 1 Press **[MENU]** key to display "Menu".

Select [MAP] => [EDIT USER DATUM] => Datum data input window will appear.

9	9	9							
1	2	3	4	5	6	7	8	9	0
A	B	C	D	E	F	G	H	I	J
K	L	M	N	O	P	Q	R	S	T
U	V	W	X	Y	Z	+	-	/	?
←	→							DEL	
EXIT								SPACE	

- 2 Select each letter one by one and press **[ENT]** key after each letter, when finished select [EXIT] and press **[ENT]** key.

6.14 POSITION OFFSET

This is to select OFFSET input of position.

Selection values: DTM, MAN

- 1 Press **MENU** key to display "Menu".
Select [MAP] => [OFFSET] => select [DTM] or [MAN], and press **ENT** key.

POSITION MANUAL OFFSET

LAT/LON position offset values input is available only when [MAN] of [POSITION OFFSET] menu is selected.

- 1 Press **MENU** key to display "Menu".
Select [MAP] => [MAN OFFSET] => input offset value of latitude/longitude separately => and press **ENT** key.
Selection values: 1.000S to 1.000N
1.000W to 1.000E

6.15 WPT FLAG

This function is related to MONITORED ROUTE function. When route or waypoint is inputted from external device flag will be shown of first waypoint. When route and waypoint information is inputted the first waypoint on a route takes priority and flag is displayed. Follow below procedure to turn [WPT FLAG] on or off.

- 1 Press **MENU** key to display "Menu".
Select [MAP] => [WPT FLAG] => select [ON] or [OFF], and press **ENT** key.

6.16 LAT/LON LINE

LAT/LON LINE is a function which when enabled displays geographical latitude and longitude lines on the radar display. Follow below procedure to turn LAT/LON LINE on and off.

- 1 Press **MENU** key to display "Menu".
Select [MAP] => [LAT/LON LINE] => select [ON] or [OFF], and press **ENT** key.

6.17 C-MAP chart display

This radar can display chart of C-MAP. The CHART and CHART DISP SET menu are displayed when C-MAP chart of SD-card type has been inserted on the front of the radar.

Chart on/off

- 1 Press **MENU** key to display "Menu".
Select [MAP] => [CHART] => select [ON] or [OFF], and press **ENT** key.

Setting of the detailed chart display

- 1 Press **MENU** key to display "Menu".
Select [MAP] => [CHART DISP SET] => select item of detailed setting, and select [ON] or [OFF]
=> press **ENT** key.

Setting item: LAND FILL, PLACE NAME, LIGHTHOUSE, BUOY, FISH HAVEN/WRECK, TRAFFIC ROUTES, CAUTION AREA, FISHERY, CABLE

- This page intentionally left blank.-

Chapter 7 System and Maintenance menu operation

7.1 SYSTEM MENU

INTER-SWITCH: Refer to 2.30 Inter-switch

TIME

USER

SOUND

LANG

DISP INFO

HELP

7.2 Change UTC / LOCAL time

1 Press **[MENU]** key to display "Menu".

Select **[SYSTEM]** => **[TIME]** => select **[UTC]** or **[LOCAL]**, and press **[ENT]** key.

[UTC / LOCAL] time can be changed directly at the "ASSISTANT INFO DISP" area, with trackball/joystick and **[ENT]** key, without using menu.



A screenshot of a ship's information display. The title is 'OWN SHIP INFO'. The first line is 'UTC 18/03/16 00:59', with a yellow arrow pointing to the 'UTC' label. Below it are 'DGPS 35°14.634N' and '139°48.191E'. Further down are 'COG 020.5°', 'SOG 10.5kn', 'SET 20.5°', and 'DRIFT 10.5kn'.

Parameter	Value
UTC	18/03/16 00:59
DGPS	35°14.634N 139°48.191E
COG	020.5°
SOG	10.5kn
SET	20.5°
DRIFT	10.5kn

Note: Refer to 2.34.4 ASSISTANT INFO DISP

Refer to **[MAINTENANCE]** => **[I/O]** => **[TIME]** menu for detailed how to set time.

7.3 User memory

This radar is equipped with four user memory slots. All functions and settings can be memorized in the user memory slots and names can be edited individually.

Change USER memory

- 1 Press **MENU** key to display "Menu".
Select [SYSTEM] => [USER] => select new user memory [1name to 4 name] => [GO], and press **ENT** key.

How to save to memory

All operations are automatically saved in selected user memory slot in real time as they take place so no action is required from user to save settings.

Edit User Name

The used user memory's name can be changed by next operation.

- 1 Press **MENU** key to display "Menu".
Select [SYSTEM] => [USER] => [EDIT USER NAME] =>
- 2 Edit user name window will appear and can change user name.
Maximum 10 letters or numbers can be set for the name.
After name has been changed, press **ENT** key to save setting.

Default User setting

Using these steps it is possible to clear all data associated with currently selected user.

To delete all user settings and return to default, follow below procedure.

- 1 Press **MENU** key to display "Menu".
Select [SYSTEM] => [USER] => [DEFAULT SETTING] => [GO], and press **ENT** key.
This operation will clear all information stored in current user memory.

7.4 Sound setting

Sound menu is to turn sound ON/OFF, setup frequency of sound in Operation unit, key click sound and external buzzer.

Sound ON/OFF

- 1 Press **MENU** key to display "Menu".
Select [SYSTEM] => [SOUND] => [SOUND] => select [ON] or [OFF], and press **ENT** key.

Sound frequency

- 1 Press **MENU** key to display "Menu".
Select [SYSTEM] => [SOUND] => [FREQUENCY] => select [1 to 8], and press **ENT** key.
Selection values: 1 to 8
1: Lowest frequency
8: Highest frequency

Key click ON/OFF

- 1 Press **MENU** key to display "Menu".
Select [SYSTEM] => [SOUND] => [KEY CLICK] => select [ON] or [OFF], and press **ENT** key.

External buzzer setting

External buzzer signal (Failure alarm) can be output from J1 connector on the back panel.

Output signal is relay contact. (Alarm contact will close in case of failure)

Output of relay contact is continuous when set to continue.

Output of relay contact is intermittent when set to interval.

- 1 Press **MENU** key to display "Menu".
Select [SYSTEM] => [SOUND] => [EXT BUZZER] => select [OFF], [CONTINUE] or [INTERVAL],
and press **ENT** key.

7.5 LANGUAGE select

MDC-5200 and MDC-5500 series radar can use the language of English or Japanese selected by menu.

- 1 Press **MENU** key to display “Menu”.
Select [SYSTEM] => [LANG] => [ENGLISH] or [日本語], and press **ENT** key.

Without menu operation

To Japanese

- 1 Press **POWER ON/OFF** key to turn on while keeping **RANGE+** key.
- 2 Keep **RANGE+** key pressed until the start-up screen is displayed, then release the **RANGE+** key.
Language changes to Japanese.

To English

- 1 Press **POWER ON/OFF** key to turn on while keeping **RANGE-** key.
- 2 Keep **RANGE-** key pressed until the start-up screen is displayed, then release the **RANGE-** key.
Language changes to English.

7.6 DISPLAY INFORMATION (DISP INFO)

This radar can reduce the radar information items to watch radar image wider.

Selection items are ALL/ MAIN/ OFF, the indication information is as follows.

- 1 Press **MENU** key to display “Menu”.
Select [SYSTEM] => [DISP INFO] => select [ALL], [MAIN] or [OFF], and press **ENT** key.



ALL

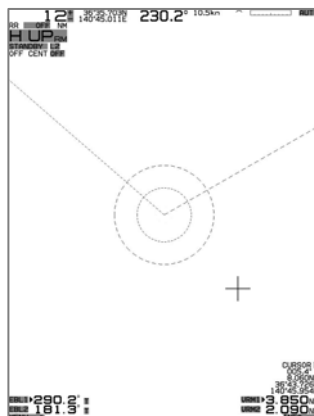

MAIN

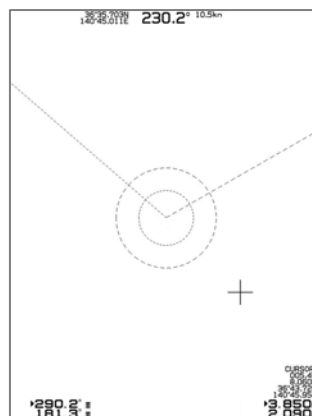

OFF

During “Menu” operation, all information will be displayed even if [DISP INFO] menu is selected to be [MAIN] or [OFF].

7.7 UPPER DISP setting

Select the upper display information from [LAT/LON], [SET/DRIFT], [TIME] or [OFF].

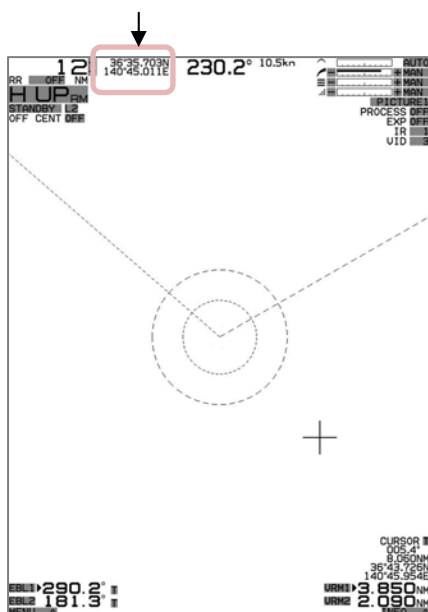

35°09.013N 135°11.588E	LAT/LON
000.0° 0.0kn	SET/DRIFT
13/02/16 07:23	TIME

7.8 HELP window ON/OFF

Help window is displayed at the lower right of the display. When the help window menu is on, it displays a procedure of complicated operation such as ALARM and MAP menu.

- 1 Press **MENU** key to display "Menu".
Select [SYSTEM] => [HELP] => select [ON] or [OFF], and press **ENT** key.

```
Map ADD Operation
ACQ:Select item
ENT:Insert to the
    point
OFF:Divide the item
MENU:Exit of edit
```

7.9 MAINTENANCE MENU

STARTUP: Refer to 4.1_STARTUP menu of Installation manual

I/O: Refer to 4.2_Setup I/O Interface of Installation manual

SECTOR MUTE: Refer to 4.3_Setup SECTOR MUTE mode of Installation manual

PRESET: Refer to 4.4_Setup PRESET of Installation manual

BACKUP:

BITE: Refer to Chapter 9 Simple fault diagnosis

TOTAL HOUR

TX HOUR

MENU SETUP

VERSION

7.10 BACKUP of Setup data (Cannot be used while transmitting)

By saving setup data to the internal memory or external memory, the initial setup and all settings are saved, in the event that the radar needs to be reinitialized or some setup changes been made, user can go back to the original settings by restoring from memory.

Backup of setup data should be saved after initial setup.

In case of malfunction of display where re-initialization must be done, restore of backup data completed at the time of original setup will bring all proper settings and tuning setup back to normal operation.

Internal save of setup data

To save data internally at the time of setup,

- 1 Press **MENU** key to display "Menu".
Select [MAINTENANCE] => [BACKUP] => [SETUP SAVE] => [GO], and press **ENT** key.

To restore from internally backup after re-initialization,

- 1 Press **MENU** key to display "Menu".
Select [MAINTENANCE] => [BACKUP] => [SETUP LOAD] => [GO], and press **ENT** key.

External save of setup and map data (Cannot be performed while transmitting)

To save setup and map data externally, this information can be later used to restore after a possible malfunction.

The external memory uses an SD memory card.

CAUTION: Please do not use the SD memory card which is loaded with software program files.

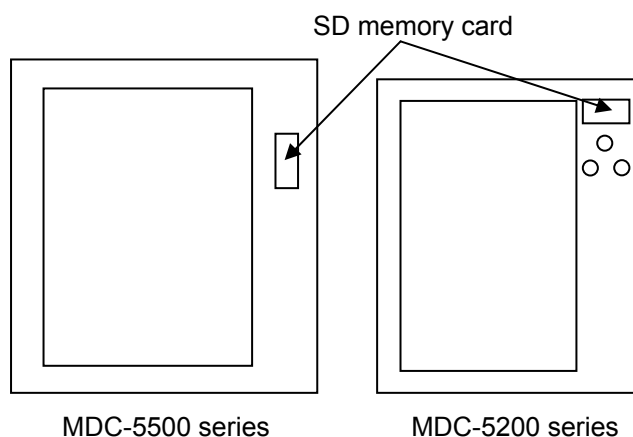
**To perform external backup to SD card,**

- 1 Insert SD memory card in card reader on the front panel.
- 2 Press **[MENU]** key to display "Menu".
 Select [MAINTENANCE] => [BACKUP] => [SD CARD] => select [SETUP SAVE], [MARK SAVE], [TGT TRACK SAVE] or [OWN TRACK SAVE] => [CANCEL] or [GO], and press **[ENT]** key.
 When SD memory card not inserted, [SD CARD] menu is greyed out and cannot be operated.

To restore from SD card backup after re-initialization,

- 1 Insert SD card that was used to store settings in above procedure in the card reader on front panel.
- 2 Press **[MENU]** key to display "Menu".
 Select [MAINTENANCE] => [BACKUP] => [SD CARD] => select [SETUP LOAD], [MARK LOAD], [TGT TRACK LOAD] or [OWN TRACK LOAD] => [CANCEL] or [GO], and press **[ENT]** key.
 When SD memory card not inserted or no data found on the card, [SD CARD] menu is greyed out and cannot be operated.

CAUTION: Put the cover firmly after the SD card Insert /Remove. Water protection of the Display unit is not guaranteed when the card reader cover is removed.

Parameter reset

Use this function as means to return the radar to its default settings as it was at first power on.

- 1 Press **MENU** key to display "Menu".
Select [MAINTENANCE] => [BACKUP] => [PARAMETER RESET] => [RESET] => and press **ENT** key.
Note: Parameter reset is active after a restart.

MAP/PAST reset

This function resets all the data of Map, Target track and Own ship in the Display unit.

- 1 Press **MENU** key to display "Menu".
Select [MAINTENANCE] => [BACKUP] => [MAP/PAST RESET] => [RESET] => and press **ENT** key.

7.11 TOTAL HOUR and TX HOUR (Cannot be used while transmitting)

[TOTAL HOUR] menu indicates the total operating time of the radar.

This menu can reset total hour to 0.

- 1 Press **MENU** key to display "Menu".
Select [MAINTENANCE] => [TOTAL HOUR] => [RESET], and press **ENT** key.

[TX HOUR] menu indicates the total transmitting time of the radar.

This is useful information to use when exchanging radar parts. Use this hour information to judge magnetron life expectancy.

Reset after components have been exchanged

- 1 Press **MENU** key to display "Menu".
Select [MAINTENANCE] => [TX HOUR] => [RESET], and press **ENT** key.

7.12 MENU SETUP

[MENU SETUP] menu can be used to simplify full menu and turn off the items in full menu that are not used. This is often used to remove not needed menu items for simple operation of the radar.

- 1 Press **MENU** key to display "Menu".
Select [MAINTENANCE] => [MENU SETUP] => [GO], and press **ENT** key.
Setup menu display will display.
- 2 Select menu item to set [ON] or [OFF] => select [X] or [O], and press **ENT** key.
- 3 When setup finish, press **MENU** key. Menu display will disappear.
Press **MENU** key again. [X] mark menu items are not displayed.

>ECHO	
PICTURE MODE	x
PROCESS	x
EXPANSION	x
IR	O
VIDEO CONTRAST	O
NOISE REJ	O
COLOR REJ	O
SP/LP	O
PULSE WIDTH	O
PICTURE RESET	O
>ECHO	O

>ECHO	
IR	OFF
VIDEO CONTRAST	3
NOISE REJ	OFF
COLOR REJ	>
SP/LP	SP
PULSE WIDTH	>
PICTURE RESET	>

← When set [>ECHO] to [x], all ECHO menu items will not be available.

7.13 System Program

Version confirmation

Currently installed firmware version can be found by using following menu operation.

1 Press **MENU** key to display "Menu".

Select [MAINTENANCE] => [VERSION] =>

(MDC-5200 series)

MRD-111

KM-F54 xx.xx

PANEL

KM-F49 xx.xx

(MDC-5500 series)

MRD-109

KM-F54 xx.xx ⇐ Firmware version of Display unit

MRO-108

KM-F45 xx.xx ⇐ Firmware version of Operation unit

How to update the system program

- 1 Prepare SD memory card with latest program.

File name: radar

File type: MOT

- 2 Turn off the power.
- 3 Insert SD memory card on front panel.

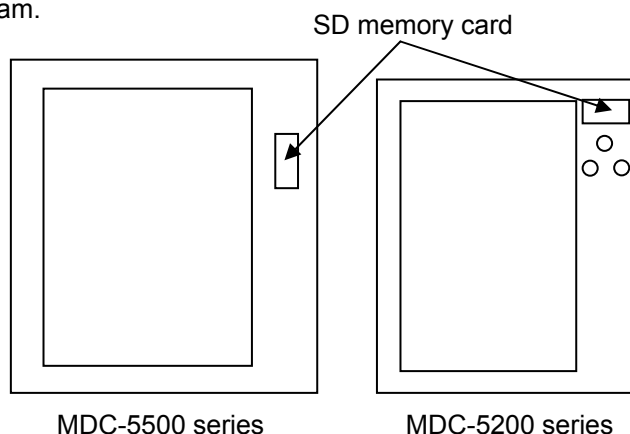

- 4 Press **POWER ON/OFF** key to turn on, radar will start update procedure automatically.
 Message of "LOADING IN PROGRESS", "PLEASE DO NOT POWER OFF" etc., and time bar will be displayed.
 During updating, **EBL1** and **VRM1**, **EBL2** and **VRM2**, **BRILL** and **PANEL** key's lamps flash red. (MDC-5500 series only)
 Few minutes later, when program update is complete, "LOADING COMPLETE" and "PLEASE EJECT SD CARD" messages will appear on the display.
- 5 Remove SD memory card from the card reader, and new system program will run automatically.
 The list of updated program file will be shown on the display.

In some cases, message of "SHUTDOWN" is displayed, and power will be turned off.

In this case, please press **POWER ON/OFF** key again, and message of "INITIALIZING" may be displayed.

CAUTION: Put the cover firmly after the SD card Insert /Remove. Water protection of the Display unit is not guaranteed when the card reader cover is removed.

- This page intentionally left blank.-

Chapter 8 Principal of radar system

8.1 What is radar system?

The radar is a navigation device that transmits a very high frequency radio wave referred to as microwave from the antenna. The radar then receives the radio wave reflected by target(s) (e.g. other ship, buoy, island, etc.) via the same antenna and converts the received radio wave to electronic signals and sends these signals to the Display unit. The radar makes it possible to find objects (targets), such as other ships, rocks or coastline, not seen by eyesight at night or in fog and allows ships to avoid these potential hazards. As the antenna transmits during 360-degree rotation, it is possible to see the current surrounding situation around your ship at a glance.

The microwave radiated from the radar is referred to as pulse wave and the transmitting and receiving of these waves is alternated. Up to thousands of pulse waves are transmitted and received during one rotation

The typical radar antenna is of parabolic type or slotted array type and its performance is essential for good radar performance. Some of factors affecting the quality of the target returns are antenna beam width and side lobe level. The narrow beam width provides high resolution for angular orientation to distinguish objects and the low side lobe level reduces false image effect.

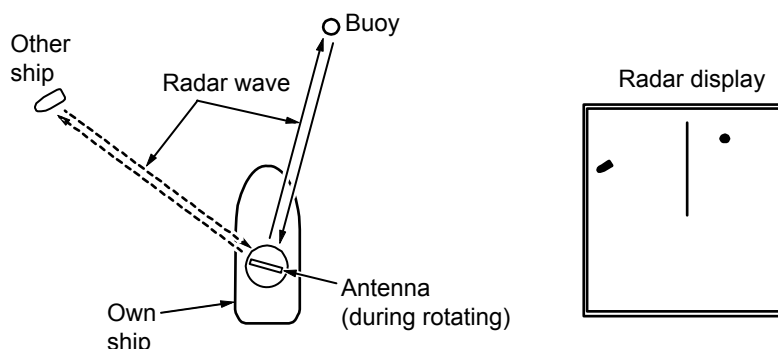

Side lobe

The main lobe means the strongest radiated beam sent from the specific antenna, and the other weaker beams, are referred to as a side lobes. A side lobe level is a difference between the largest side lobe level and main lobe level.

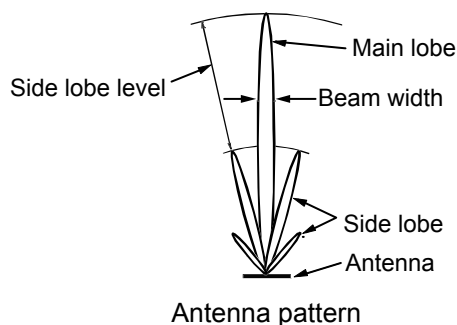

Beam width

Antenna beam width is defined as the angle where the radiation power density is within a half of maximum power density (-3 dB) in main lobe (also, referred to as “half value width”).

8.2 Characteristics of radar radio wave

The radar radio wave propagates slightly along the ground (primarily line of sight). This characteristic varies depending on density of atmosphere, but is generally calculated according to the formula as shown below, considering that the distance with radar sight D is about 6 % longer than the distance with optical sight.

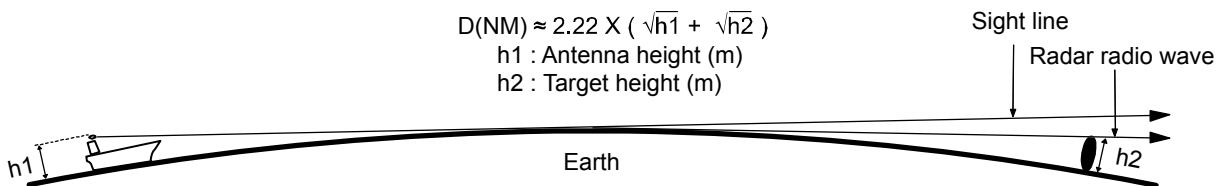

Characteristics of radar radio wave

Target hardness reflected

The strength of the reflected wave from a target varies depending on not only the distance from the target, its height or size, but also its material and features. A target with a low degree of reflection or low incident angle, such as FRP (Fiber Reinforced Plastic) and wooden ship is not reflected well. Therefore, care shall be taken that a FRP ship, a wooden ship or an object such as sand, a sandbar and muddy cay are poor radar targets.

Since the distance from the coastline, etc. to your ship on a radar image tends to be seen as longer than that from the actual coastline, more caution should be paid when navigating around such objects.

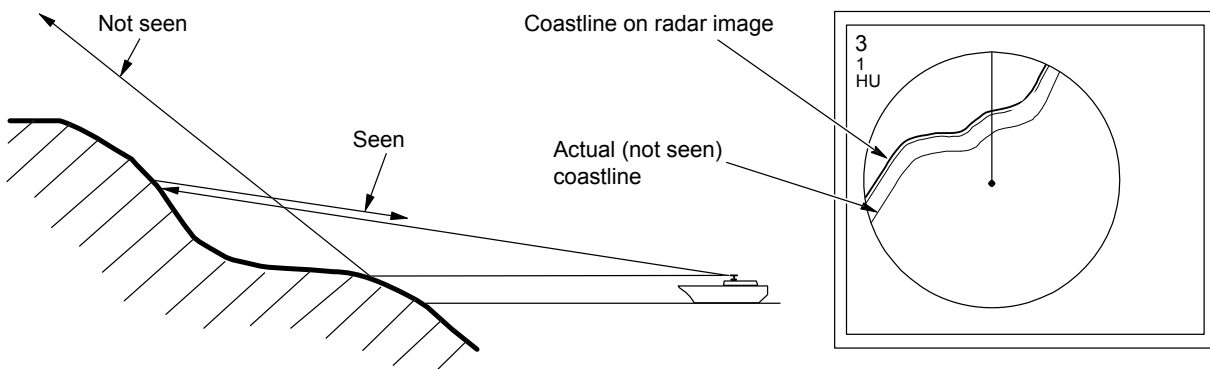

Example of targets hard to be reflected

Radar shadow

Since radar radio wave is line of sight in nature your stack mast close to the antenna or, a large ship or mountain may create blind spots for which the radar cannot penetrate. In such cases, they may completely or partially hide targets and cast a long shadow.

Since the shadow of your stack or mast is known at the time of installation, proper selection of the antenna location is necessary to reduce the shadow effect. Since targets in this shadow area is less likely to be seen than in open sea, extra attention should be paid in shadowed areas.

False image

An image that does not actually exist (false image) at sea may appear on the display.

The phenomena that causes false echoes are categorized and be described as follows:

• Virtual image

The image of a large physical object in proximity may appear in two different orientations. One is a real image and the other is a false image caused by wave re-reflected by the stack or the mast, etc. On the display, one image appears at the correct distance and bearing, and another one appears in the direction of a stack, a mast, etc. These images may also be generated by re-reflection from bridges and quays too.

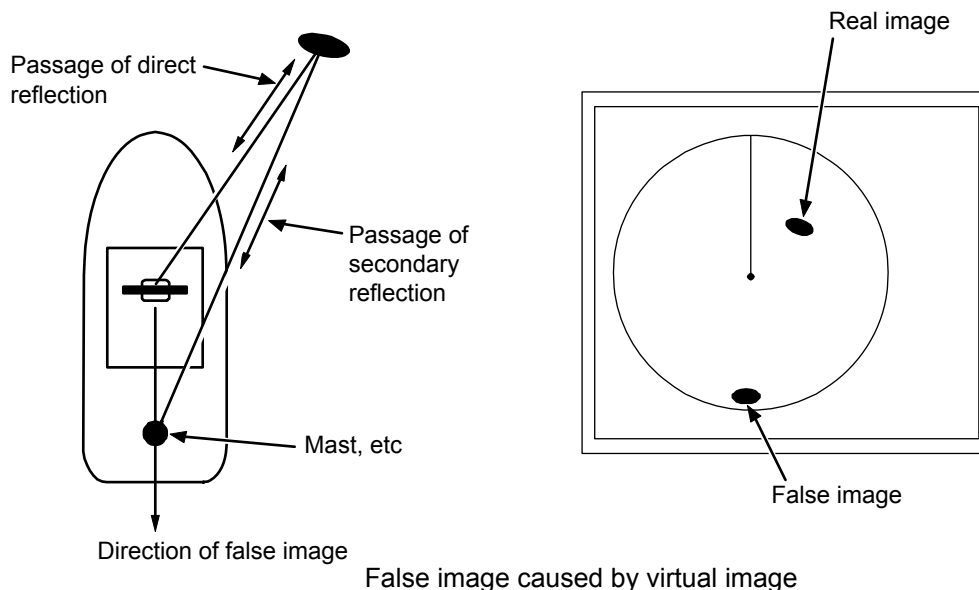

• Duplicate target images

When there is a big reflective surface nearby and it is perpendicular at a close distance (i.e. when your ship is passed by a big ship, etc.), the radio wave bounces between own ship and the other ship. Therefore, two to four images may appear at equal range in the direction of this target. The false images generated by this multi-path reflection are referred to as “double targets”. In this case, the closest target is the real image.

If the distance and bearing between own ship and the reflective target changes, then the duplicate targets will disappear. Therefore, this false image can be easily distinguished.

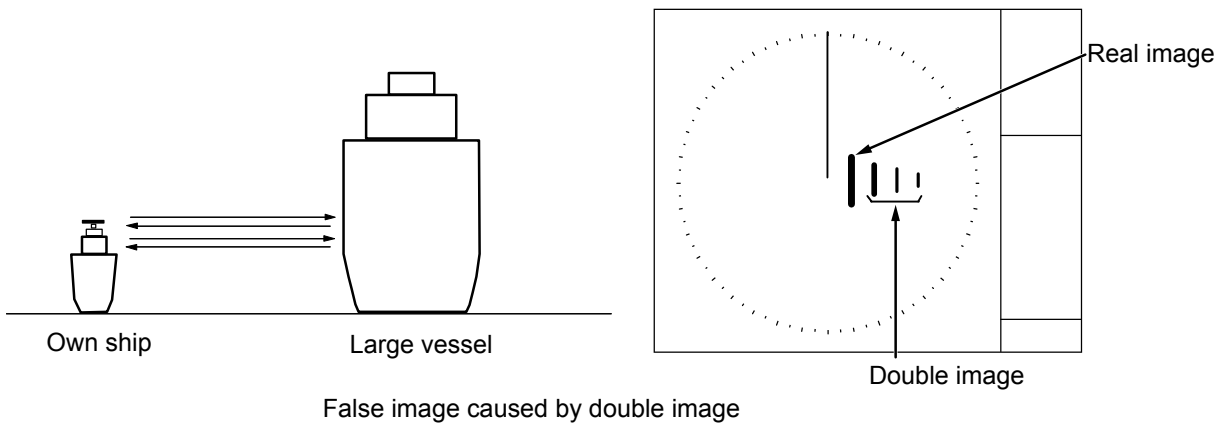

•Side lobe images

The microwave beam radiated from the antenna has a side lobe in different direction than that of the main beam. Since this side lobe level is lower than that of main beam, the effect is negligible for targets at long range, but a close, strong reflecting target may cause false image appearing in a circular arc shape.

 <p style="font-size: 24pt; font-weight: bold; margin: 0;">CAUTION</p>	<p>When own ship is close to large targets such as land, a circular image may appear.</p>
---	---

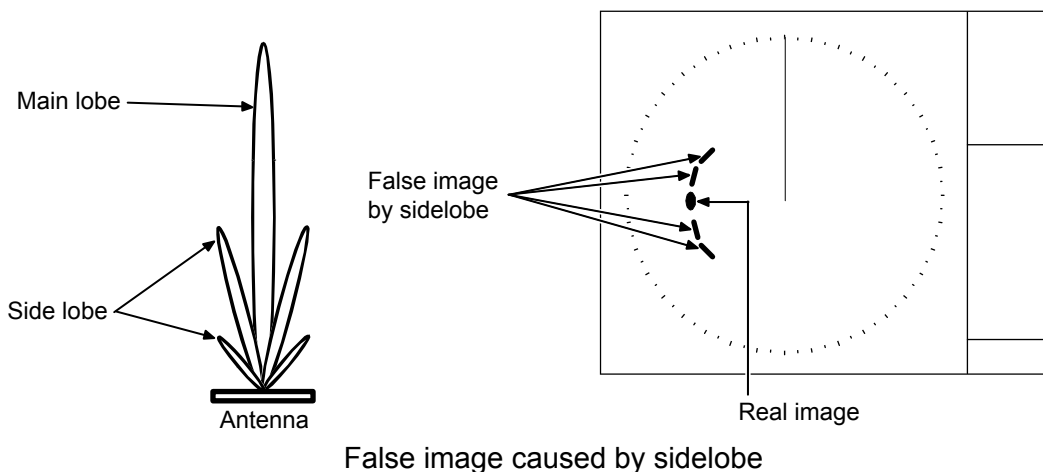

•Skip target images

False image of a distant target caused by “skip” phenomenon

Depending on weather conditions, skip caused by the temperature inversion layer of air, etc. may appear. In this case, the radio wave may unusually propagate to distant targets out of the radar range. A target at more than the maximum range may appear as an image, and may be displayed as a false image with closer distance than the actual one. This phenomenon is a result of the wide range echo delay time exceeding the transmission period, and is displayed as echo in the following rotation. If the range scale is changed and the target range is changed, it can be judged as a false image.

8.3 Radar interference

When the radar with the same frequency band is used nearby, interference noise appears on a display. Although appearance of interference is not constant, the shape is almost always swirling or radial. This series of radars features an IR (interference rejection) facility to reduce this interference.

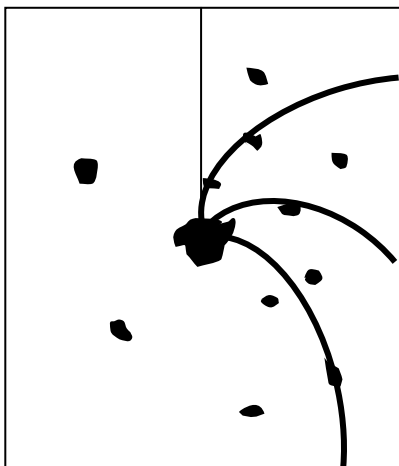

- This page intentionally left blank.-

Chapter 9 Simple fault diagnosis

For simple fault diagnosis, follow below procedures.

For faults not listed below, refer to the Installation manual.

Items posted

- 9.1 No alarm sound. (ALARM TEST)
- 9.2 Operation unit (panel) key is not operational. (PANEL TEST)
- 9.3 TT (ARPA) is not operational. (DIAGNOSE TT)
- 9.4 No AIS display. (DIAGNOSE AIS)
- 9.5 Need to confirm serial input. (SERIAL MONITOR)
- 9.6 No radar video display. (ANT MONITOR)

- 1 Press **MENU** key to display "Menu".
Select [MAINTENANCE] => [BITE] =>

```
>BITE
ALARM TEST      OFF
PANEL TEST
DIAGNOSE TT
DIAGNOSE AIS
SERIAL MONITOR
ANT MONITOR
SD CARD
```

9.1 No alarm sound

Follow this procedure to troubleshoot no alarm sound trouble.

First, select [SYSTEM] => [SOUND] and confirm that the status is [ON].

- 1 Press **MENU** key to display "Menu".
Select [MAINTENANCE] => [BITE] => [ALARM TEST] => [ON], and press **ENT** key after selection.
- 2 Alarm sounds (two times) and alarm display appears at the lower right of the display.
Alarms displayed are [WARNING B 999], [Test alert only.].





- 3 Confirmation is completed if alarm sounded.
- 4 Alarm sounds are repeated every 60 seconds.
Select [MAINTENANCE] => [BITE] => [ALARM TEST] => [OFF], and press **ENT** key to turn alarm test off.

After running the test and there is still no alarm sound the operation unit has malfunction.

9.2 Operation unit (panel) key is not operational

Following procedure is a test for operation unit in case some keys don't function properly. First please make sure all cables are connected properly.

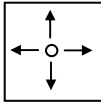
- 1 Press **MENU** key to display "Menu".
Select [MAINTENANCE] => [BITE] => [PANEL TEST] =>.
- 2 Panel illustration will appear on the display.
- 3 Press any key except **MENU** key.
[•] mark will appear at the left side of key name during the key press. (●DAY/NIGHT)
The line in the circle will rotate when the knob is turned. 
The circle color will change when the knob is pressed. 
The small circle in the square will move when trackball/joystick is moved. 



(MDC-5500 series)

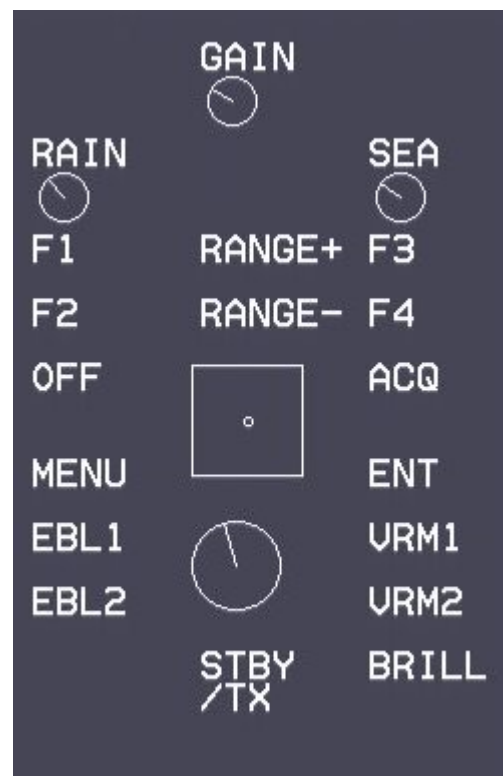

(MDC-5200 series)

- 4 Pressing **MENU** key will complete the test.

Operation unit (panel) malfunctions, if No.3 item is not normally displayed.

9.3 TT is not operational

This procedure is applied when acquisition operation does not start despite **ACQ** key being pressed.

First, confirm that [INPUT RNG] is properly set.

The targets outside of [INPUT RNG] will not be acquired.

This procedure confirms ATA function.

- 1** Press **MENU** key to display "Menu".
Select [MAINTENANCE] => [BITE] => [DIAGNOSE TT] =>.
- 2** Confirm [○] mark appears on the left side of [HDG].
- 3** Move trackball/joystick to the left to complete.

If [x] mark is displayed in step 2, then confirm HDG input for Display unit.

9.4 No AIS display

This procedure is applied when AIS is not displayed.

First, confirm that [INPUT RNG] is properly set.

Targets outside of [INPUT RNG] are not displayed.

Confirm AIS function by following steps.

- 1 Press **MENU** key to display "Menu".
Select [MAINTENANCE] => [BITE] => [DIAGNOSE AIS] =>.
- 2 Confirm that the [O] mark appears at the left side of [AIS DATA], [HDG], [SPD], [LAT/LON] and [COG/SOG].
- 3 Move trackball/joystick to the left to complete.

If [x] mark is displayed in step 2, then

In the case of [AIS DATA]: No valid AIS data input.

Confirm AIS receiver connected to Display unit.

AIS DATA is usually input to AIS (J2) connector.

In the case of [HDG]: No valid HDG input.

Confirm HDG input of Display unit.

HDG is usually input to J3/J5/J6 NMEA connector.

In the case of [SPD]: No valid SPD input.

Confirm SPD input of Display unit.

SPD is usually input to J3/J5/J6 NMEA connector.

In the case of [LAT/LON]: No valid LAT/LON input.

Confirm LAT/LON input of Display unit.

LAT/LON is usually input to J3/J5/J6 NMEA connector.

In the case of [COG/SOG]: No valid COG/SOG input.

Confirm COG/SOG input of Display unit.

COG/SOG is usually input to J3/J5/J6 NMEA connector.

9.5 Need to confirm serial input

This procedure is applied to confirm serial input of Display unit.

Serial input of connectors can be confirmed with the following 6 connectors:

AIS (J2), NMEA (J3, J5 and J6), Option1 (OP1) and Option2 (OP2).

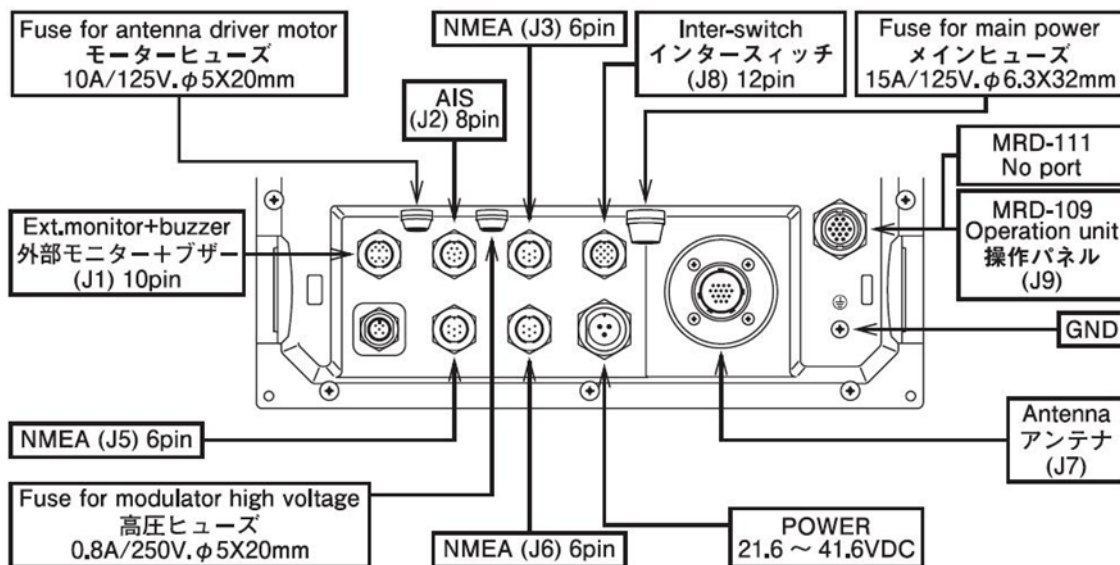

- 1 Press **[MENU]** key to display "Menu".
 Select **[MAINTENANCE]** => **[I/O]** => **[SERIAL MONITOR]** => select **[J3]**, **[J5]**, **[J6]**, **[OP1]**, **[OP2]**, **[AIS]** or **[ALL]**, and press **[ENT]** key.
[ALL] can confirm the data of all ports at a time.
- 2 Input data will be displayed.
 Since the data keeps coming in and the display keeps changing it may be hard to observe the sentences.
 By pressing **[ENT]** key, data display will stop temporarily to confirm data content.
- 3 Move trackball/joystick to left to complete.

Data confirming item in step 2

In the case that data is not displayed: Confirm input data device connected to Display unit.

In the case that data is displayed but is garbled: Confirm baud rate.

9.6 No radar video display

This procedure is applied when no radar video (Echo) is displayed on the display.

- 1** Press **[MENU]** key to display "Menu".
Select **[MAINTENANCE]** => **[BITE]** => **[ANT MONITOR]** =>.
- 2** Antenna status will be displayed.
- 3** Turn trackball/joystick to left to complete.

Antenna status criteria in step 2

Connected scanner model name and type:

HIGH VOLTAGE: If the value is other than xxx to xxx, indicates high voltage malfunction.

MAG CURRENT MONI: If the value is other than xx to xxx, indicates magnetron malfunction.

MAG HEATER: If the value is other than xx to xxx, indicates magnetron malfunction.

MOTOR MONI:

TUNE VOLTAGE: If the value is other than xx to xxx, indicates magnetron or Front End Module failure.

- This page intentionally left blank.-

Chapter 10 Specifications

10.1 Antenna and Scanner unit

Antenna

Model name	RW701A-03	RW701A-04	RW701A-06	RW701B-09
Antenna length	3feet	4feet	6feet	9feet
Horizontal beam width	2.5°	1.8°	1.2°	0.8°
Vertical beam width	22	22°	22°	25°
Side lobe within ±10°	-23dB	-25dB	-25dB	-25dB
Side lobe outside ±10°	-28dB	-30dB	-30dB	-30dB
Polarization	Horizontal			

Scanner

Model name	MDC-5204 MDC-5504	MDC-5206 MDC-5506	MDC-5212 MDC-5512	MDC-5225 MDC-5525
Scanner unit	RB806	RB807	RB808	RB809
Type	Up-mast			
Rotation	24 rpm or 48 rpm		24 rpm or 42 rpm	
Output frequency	X-band: 9410MHz ± 30MHz			
Output power (Peak)	4kW	6 kW	12 kW	25 kW
Magnetron	MAF1428BY	MAF1562R	MAF1565N	M1568BS
Temperature	-25°C to +55°C			
Water protection	IPX6			

Range, PRF, Pulse width

4 kW		6 kW, 12 kW, 25 kW															
PRF (Hz)	Pulse width	PRF (Hz)	Pulse width	Range (NM)													
				0.125	0.25	0.5	0.75	1.5	3	6	12	24	48	64	96		
2000	0.08μs	2600	0.08μs	S1													
2000	0.08μs	2600	0.15μs			S2											
1800	0.2μs	2400	0.3μs					M1									
1500	0.3μs	2000	0.4μs					M2									
1500	0.3μs	1400	0.6μs						M3								
800	0.6μs	1000	0.8μs						L1								
500	1.2μs	600	1.2μs							L2							
500	1.2μs	450	1.2μs													L3	

10.2 Display and Operation unit

Model name	MDC-5204/5206/5212/5225	MDC-5504/5506/5512/5525
Display unit	MRD-111	MRD-109
Operation unit	---	MRO-108
Display size and type	12.1 inch color LCD	15 inch color LCD
Resolution	768 X 1024 pixels (XGA)	
Effective diameter	184 mm	228 mm
Viewing distance	1 m	
Frequency band	X-band 9410MHz \pm 30MHz (9380MHz to 9440MHz)	
Speed class	Normal speed class (< 30 knot)	
Echo color	White, Yellow, Green, Multi, User1, User2	
Off centering	Max. 75%	
Range data accuracy	8 m or 1 % of range scale selected, whichever is greater	
Range	0.125, 0.25, 0.5, 0.75, 1.5, 3, 6, 12, 24, 48, 64, 96 NM Up to 48 NM for transmit output 4kW, Up to 64 NM for transmit output 6kW, 12 kW, Up to 96 NM for transmit output 25kW	
Bearing accuracy	$\pm 1^\circ$	
Presentation modes	Head up, North up*, and Course up*	
Functions	CFAR (Clutter rejection), Interference rejection, Target expansion, Process (Residual image, Averaging), VRM, EBL, Parallel index, ERBL, Cursor position (Lat/Lon)**, Bearing (true/relative)*, Trail (true/relative)***, Own ship past track, MAP (Event mark, etc.)**, RGB Monitor output, VDR output, Inter-switch, C-map chart**	
NMEA Input/output	3 CH (5 CH with JB-35)	
Power supply	21.6 VDC to 41.6 VDC	
	MDC-5204: 100 W or less	MDC-5504: 100 W or less
	MDC-5206: 130 W or less	MDC-5506: 130 W or less
	MDC-5212: 150 W or less	MDC-5512: 150 W or less
	MDC-5225: 200 W or less	MDC-5525: 200 W or less
AIS	1000 targets	
TT (ARPA)	100 targets	
Temperature	-15°C to +55°C	
Water protection	IPX5 (Operation unit (MDC-5500 series): IP23)	

*Requires heading data input.

**Requires heading and latitude/longitude data input.

***Requires heading, speed and latitude/longitude data input.

10.3 External view and dimensions

MRD-111 (MDC-5200 series)

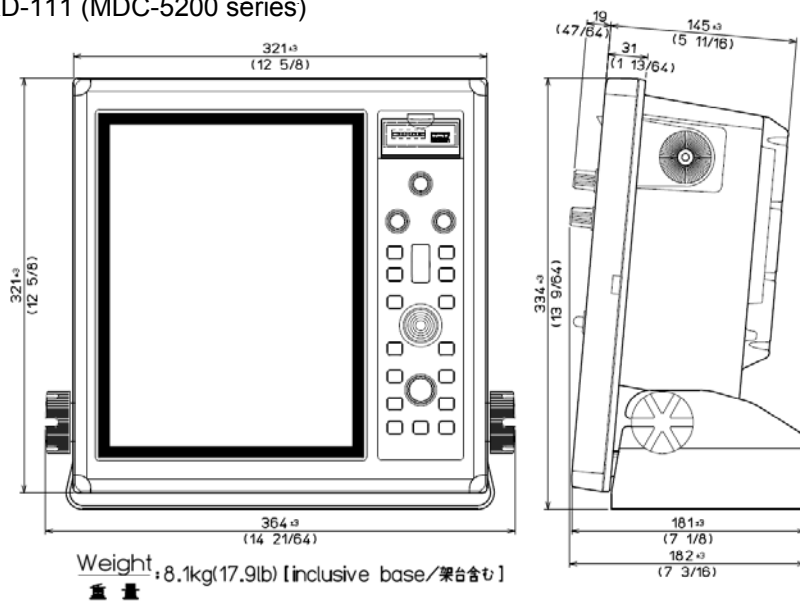

MRD-109 (MDC-5500 series)

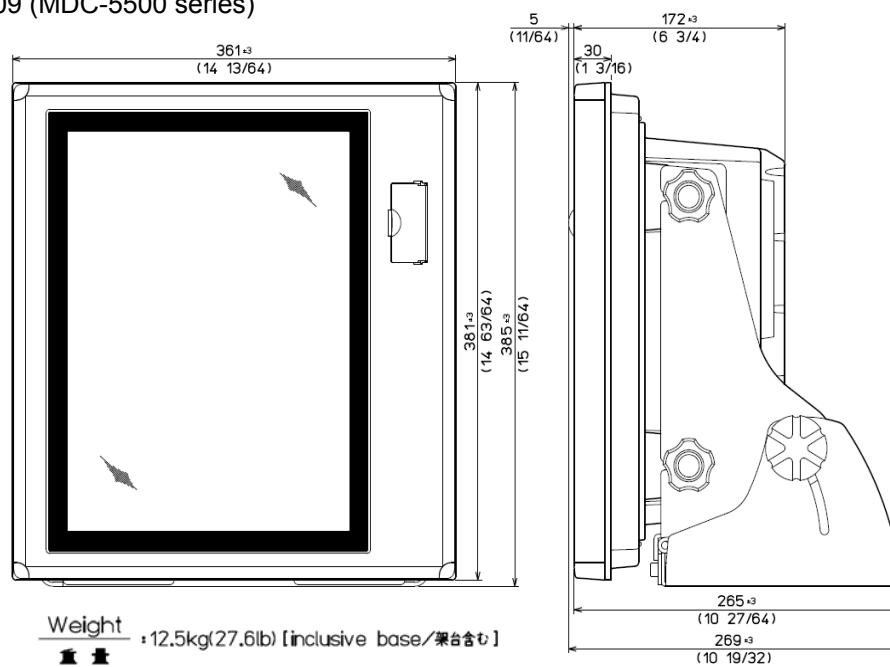

MRO-108 (MDC-5500 series)

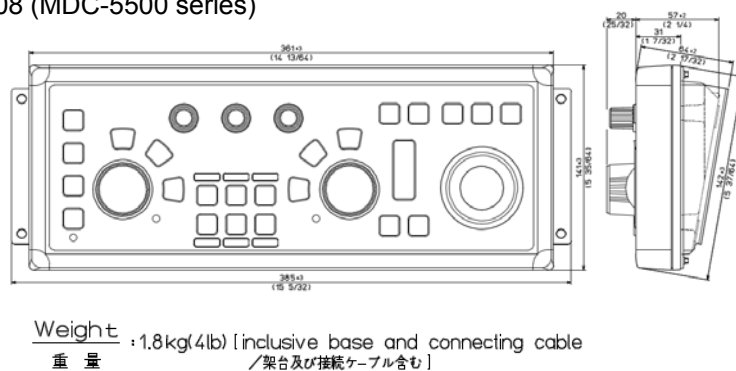

Unit: mm (inch)

RB806

3Feet:1034(40 11/16) ±5
 4Feet:1346(53) ±10
 6Feet:1970(77 9/16) ±10

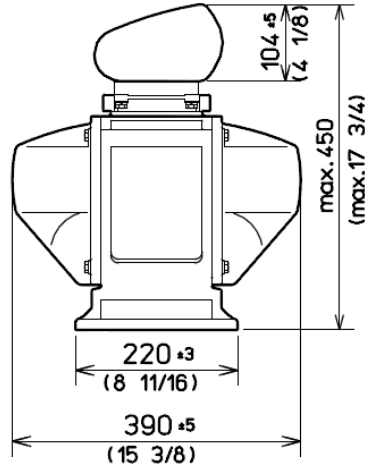
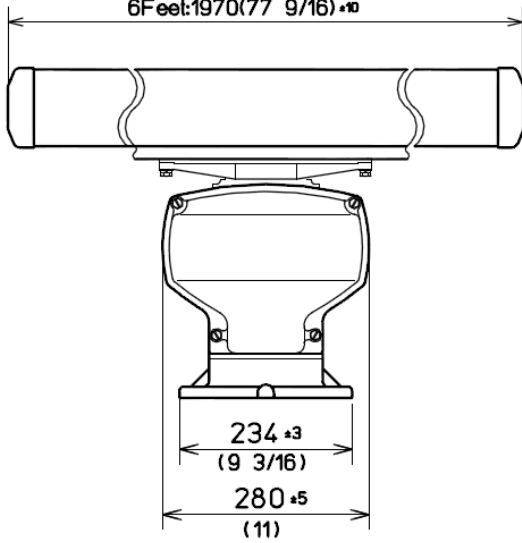

BOW

 船首

Weight : 21.5kg/(47lb) . . . 3Feet(RW701A-03)
 重量 : 22.5kg/(50lb) . . . 4Feet(RW701A-04)
 重量 : 24.5kg/(54lb) . . . 6Feet(RW701A-06)

RB807

4Feet:1346(53) ±10
 6Feet:1970(77 9/16) ±10

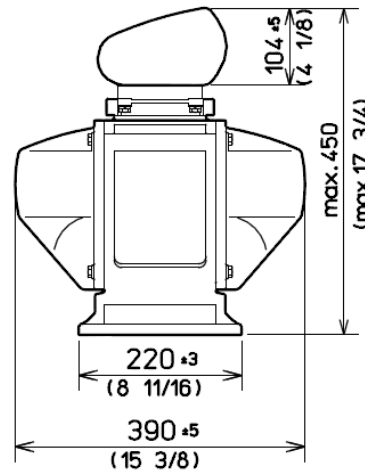
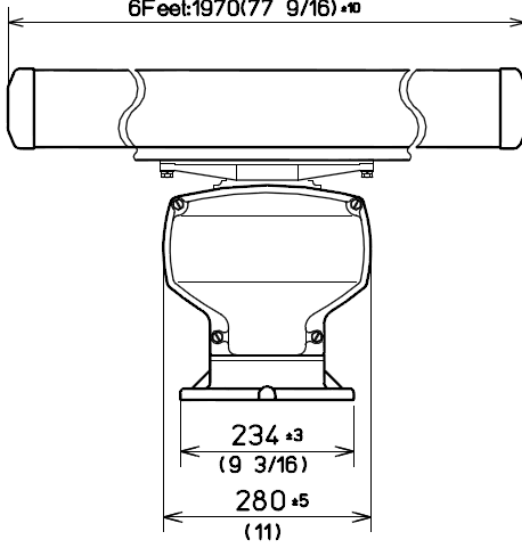

BOW

 船首

Weight : 24.1kg/(53lb) . . . 4Feet(RW701A-04)
 重量 : 26.1kg/(58lb) . . . 6Feet(RW701A-06)

Unit: mm (inch)

RB808

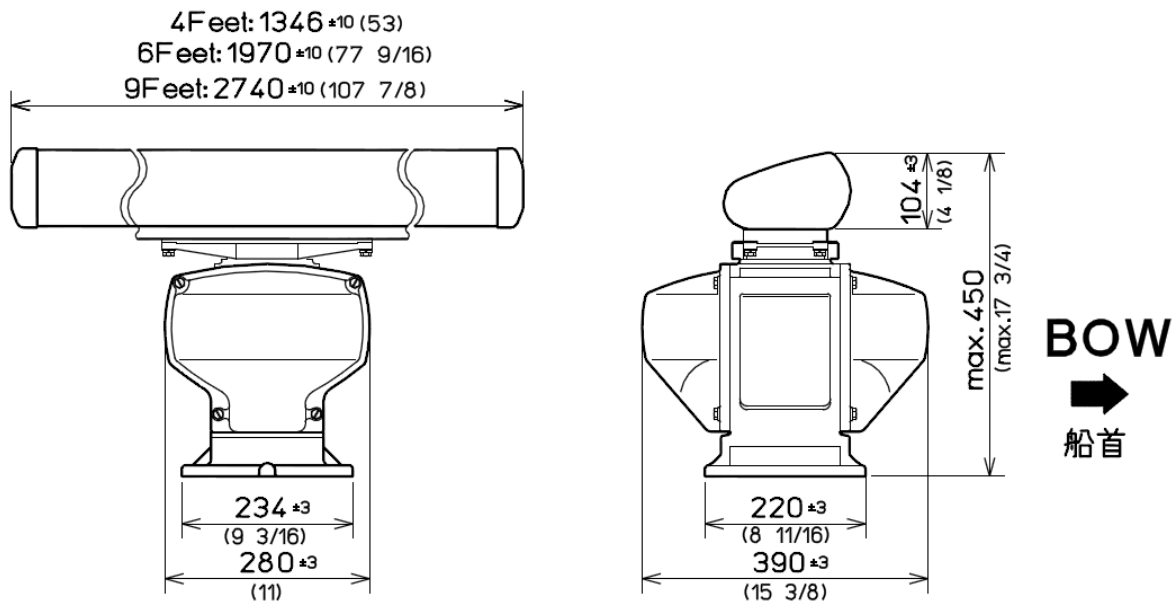

Weight : 24kg±2kg(53lb) : (RW701A-04)
 重量 26kg±2kg(57.5lb) : (RW701A-06)
 30kg±2kg(66.5lb) : (RW701B-09)

RB809

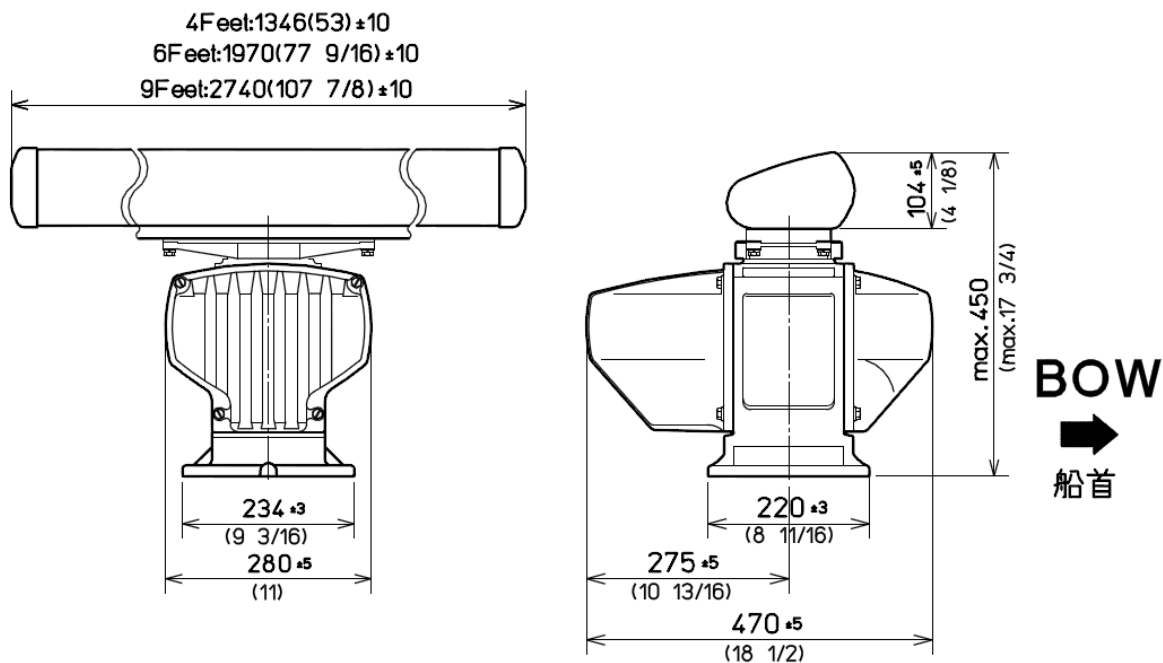

Weight : 26kg±2kg(57.5lb) : (RW701A-04)
 重量 28kg±2kg(62lb) : (RW701A-06)
 32kg±2kg(71lb) : (RW701B-09)

Unit: mm (inch)

- This page intentionally left blank.-

Chapter 11 Appendix

11.1 Menu tree

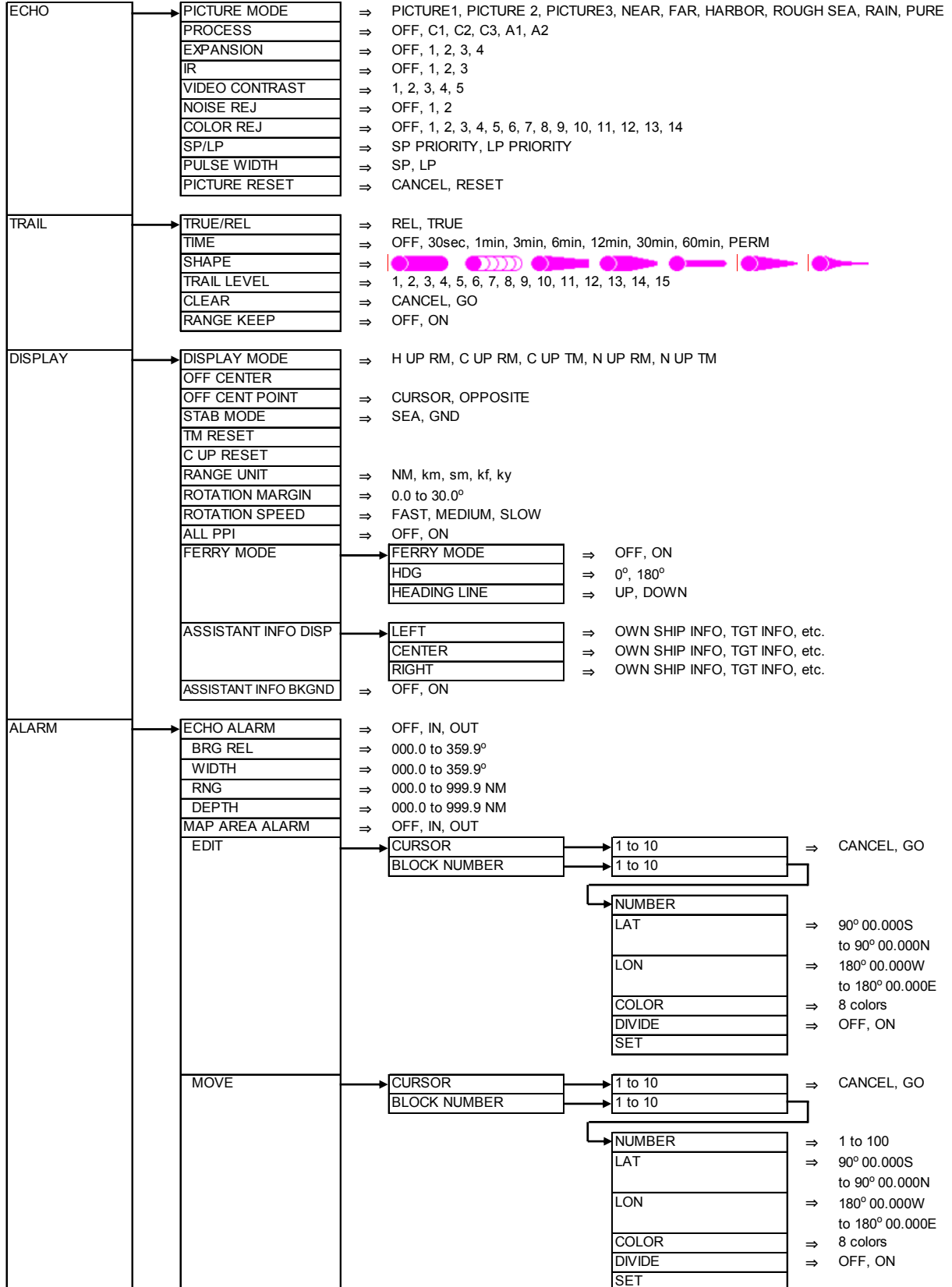

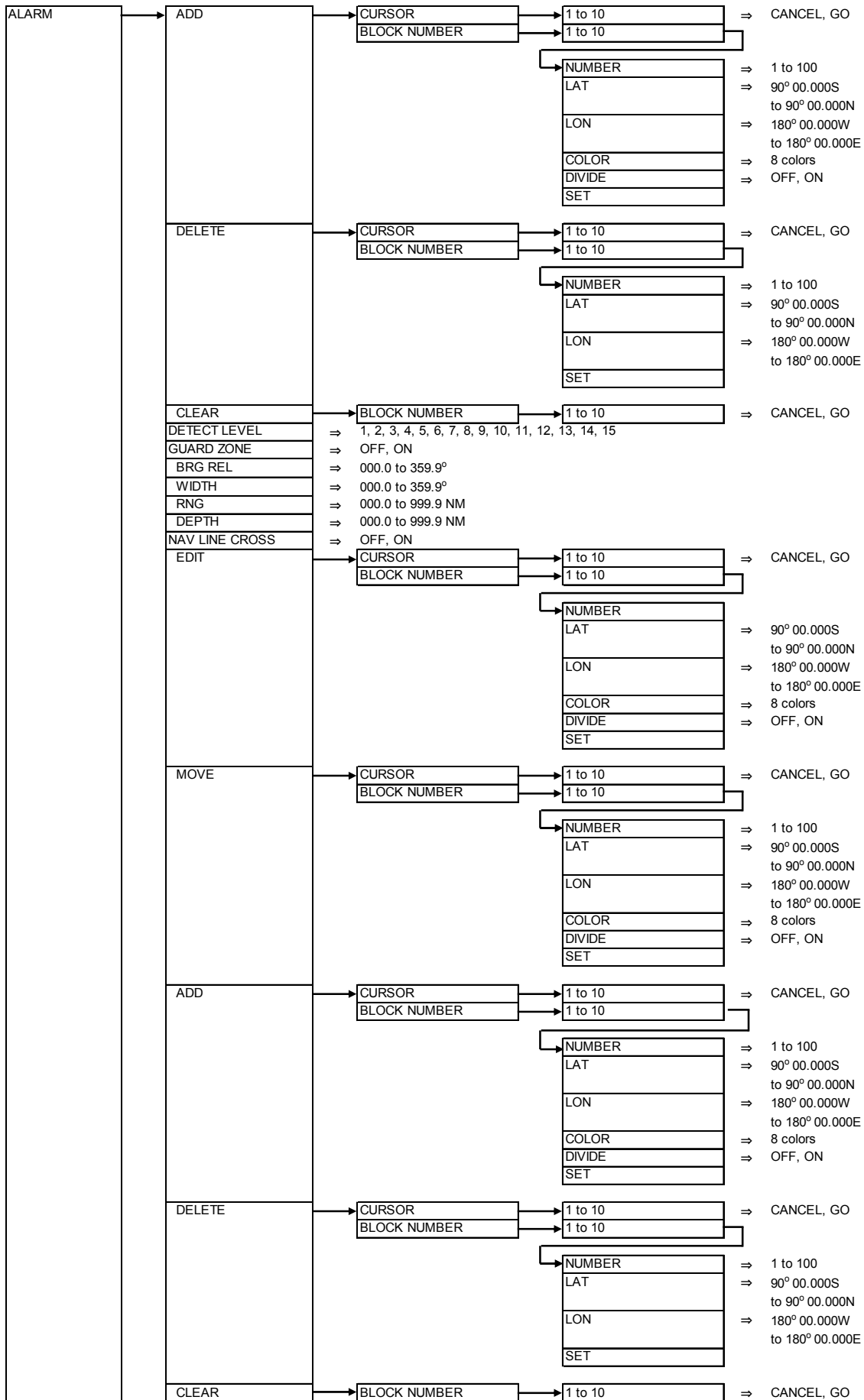

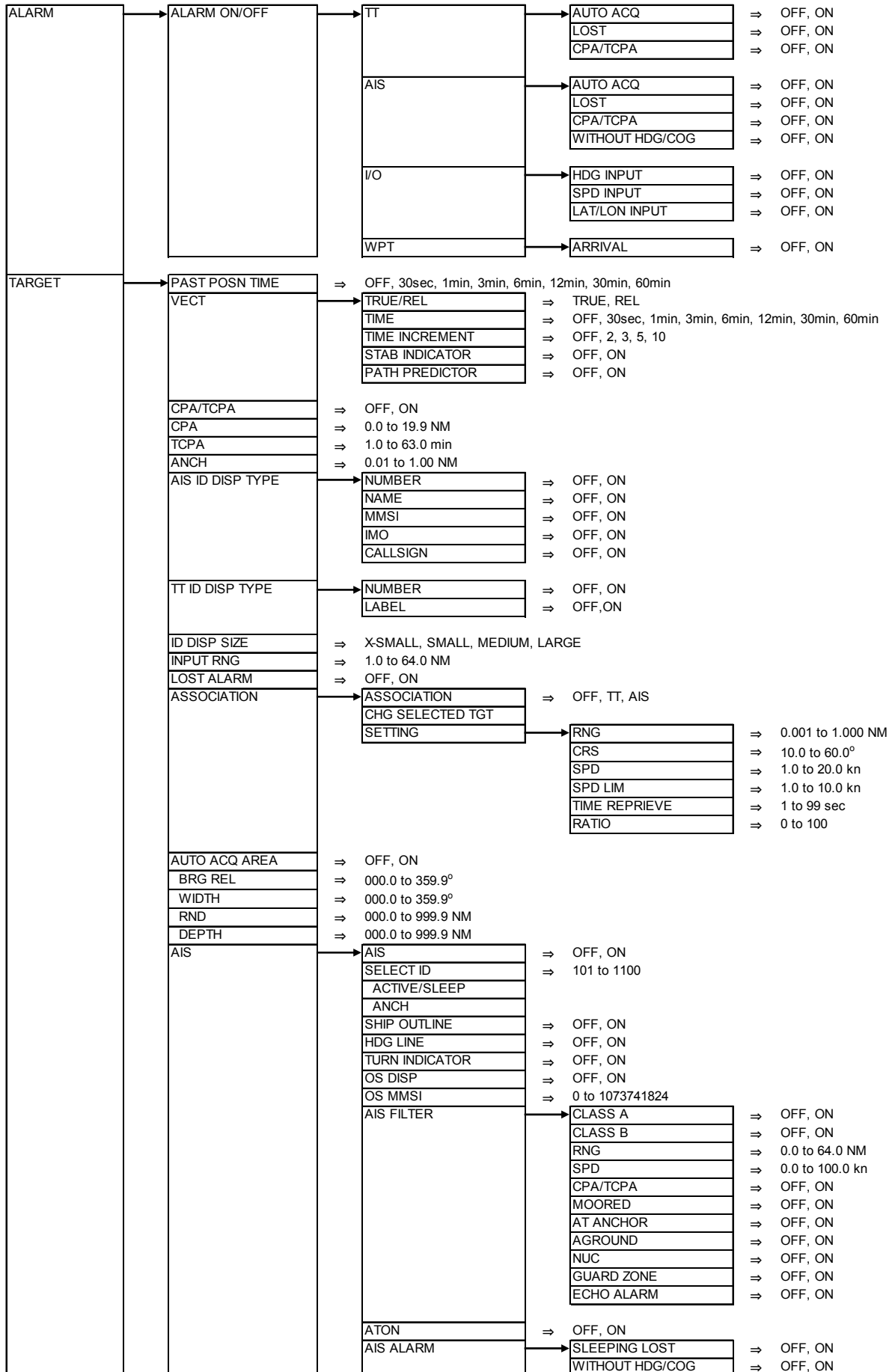

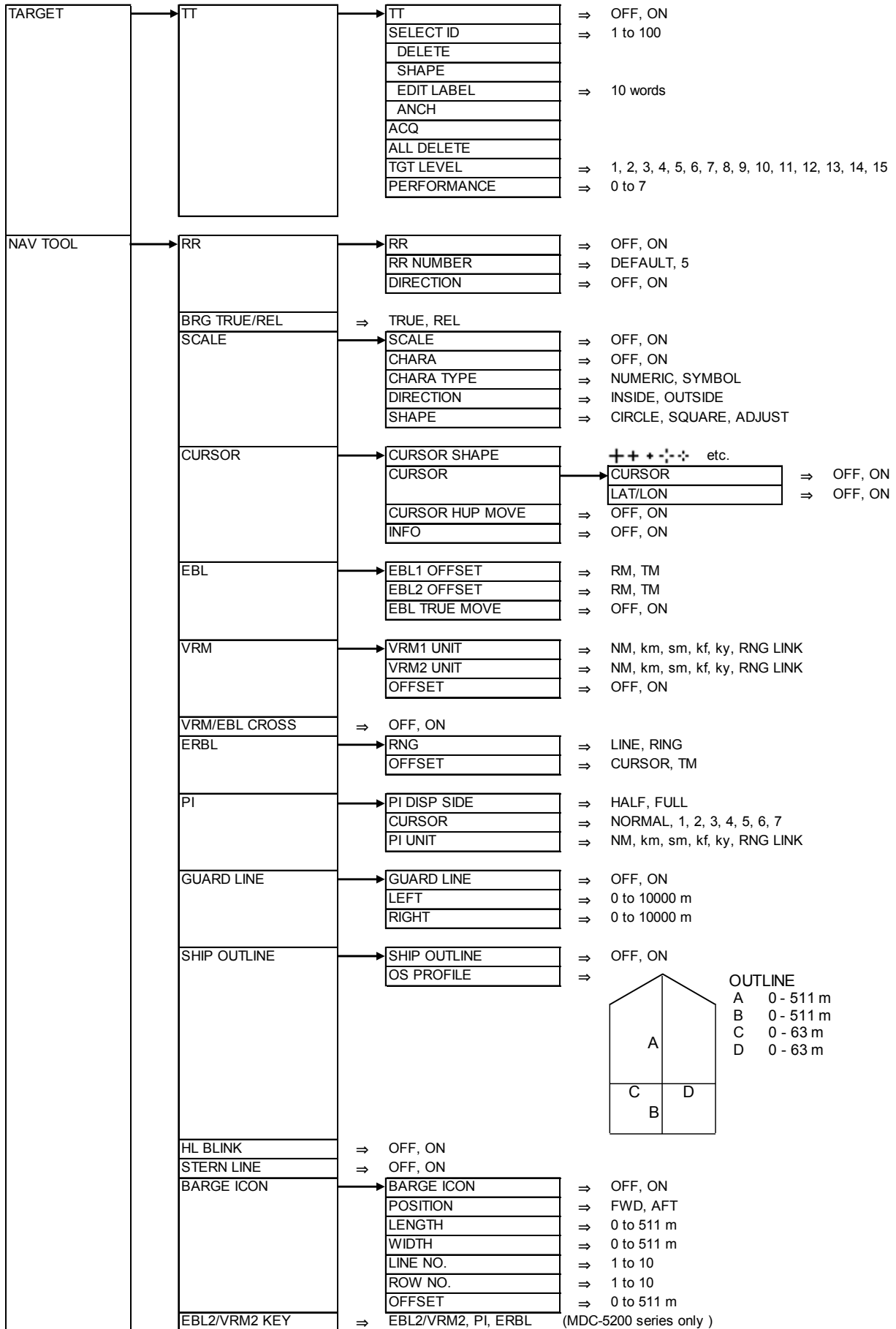

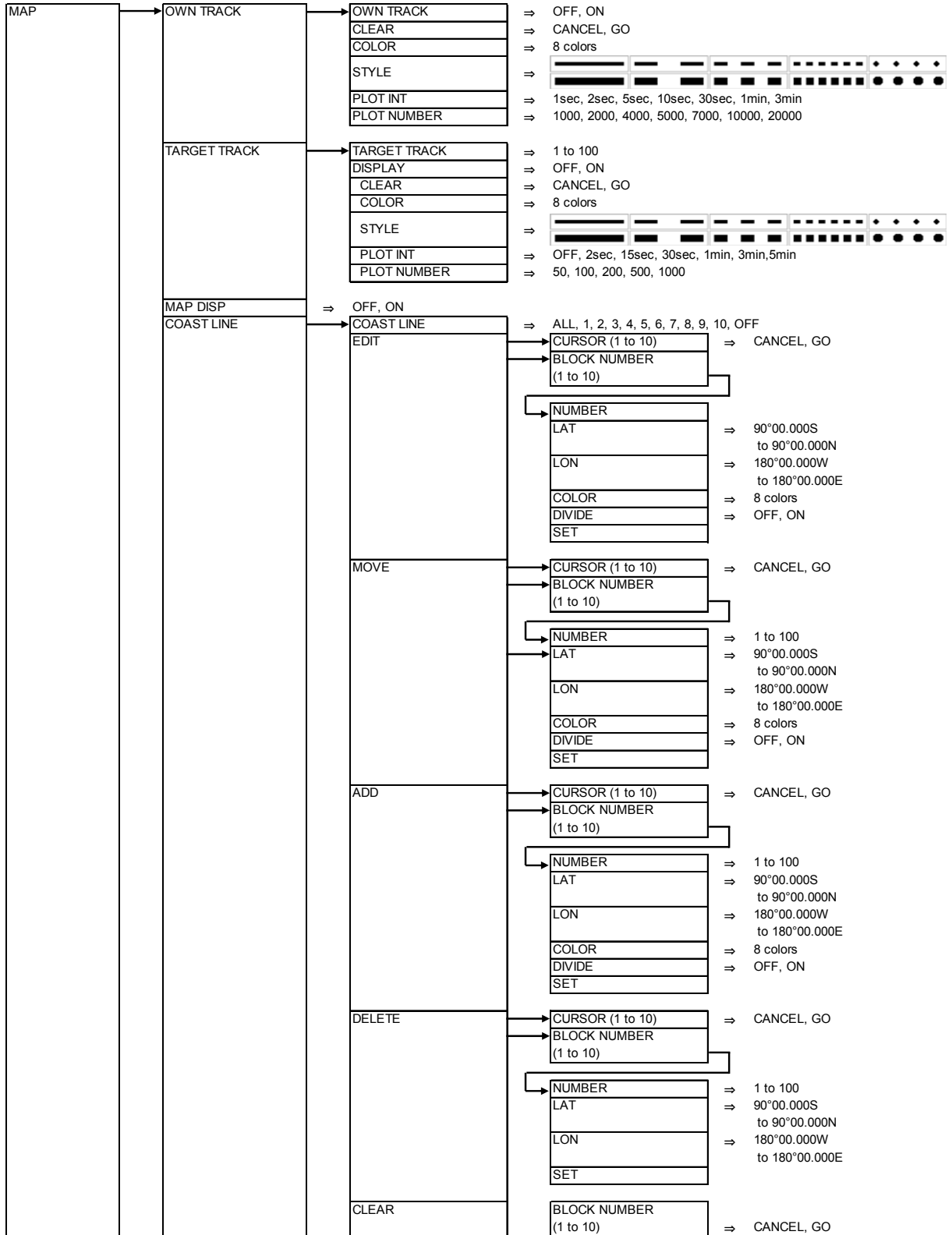

MAP	NAV LINE	NAV LINE	⇒ ALL, 1, 2, 3, 4, 5, 6, 7, 8, 9, 10, OFF
		EDIT	⇒ Same COAST LINE => EDIT
		MOVE	⇒ Same COAST LINE => MOVE
		ADD	⇒ Same COAST LINE => ADD
		DELETE	⇒ Same COAST LINE => DELETE
		CLEAR	⇒ Same COAST LINE => CLEAR
	ROUTE	ROUTE	⇒ ALL, 1, 2, 3, 4, 5, 6, 7, 8, 9, 10, OFF
		EDIT	⇒ Same COAST LINE => EDIT
		MOVE	⇒ Same COAST LINE => MOVE
		ADD	⇒ Same COAST LINE => ADD
		DELETE	⇒ Same COAST LINE => DELETE
		CLEAR	⇒ Same COAST LINE => CLEAR
	EVENT MKR	EVENT MKR	⇒ ALL, 1, 2, 3, 4, 5, 6, 7, 8, 9, 10, OFF
		EDIT	⇒ Same COAST LINE => EDIT
		MOVE	⇒ Same COAST LINE => MOVE
		ADD	⇒ Same COAST LINE => ADD
		DELETE	⇒ Same COAST LINE => DELETE
		CLEAR	⇒ Same COAST LINE => CLEAR
	AREA	AREA	⇒ ALL, 1, 2, 3, 4, 5, 6, 7, 8, 9, 10, OFF
		EDIT	⇒ Same COAST LINE => EDIT
	MOVE	⇒ Same COAST LINE => MOVE	
	ADD	⇒ Same COAST LINE => ADD	
	DELETE	⇒ Same COAST LINE => DELETE	
	CLEAR	⇒ Same COAST LINE => CLEAR	
MONITORED ROUTE		⇒ OFF, ON	
WPT ID DISP		⇒ OFF, ON	
TARGET TRACK ID		⇒ OFF, ON	
DATUM		⇒ W84, W72, S85, P90, 999	
EDIT USER DATUM		⇒ 3 words	
OFFSET		⇒ DTM, MAN	
MAN OFFSET		⇒ 1.000S to 1.000N	
		⇒ 1.000W to 1.000E	
WPT FLAG		⇒ OFF, ON	
LAT/LON LINE		⇒ OFF, ON	
CHART		⇒ OFF, ON	
CHART DISP SET	LAND FILL	⇒ OFF, ON	
	PLACE NAME	⇒ OFF, ON	
	LIGHTHOUSE	⇒ OFF, ON	
	BUOY	⇒ OFF, ON	
	FISH HAVEN/WRECK	⇒ OFF, ON	
	TRAFFIC ROUTES	⇒ OFF, ON	
	CAUTION AREA	⇒ OFF, ON	
	FISHERY	⇒ OFF, ON	
	CABLE	⇒ OFF, ON	
DEPTH CON			
BRILL	DAY/NIGHT		⇒ DAY, NIGHT
	ECHO		⇒ WHITE, YELLOW, GREEN, MULTI, USER1, USER2
	TRAIL		⇒ BLUE, BROWN, USER1, USER2
	BKGND PPI		⇒ BLACK, BLUE, USER1, USER2
	BKGND DATA		⇒ BLACK, BLUE, USER1, USER2
	DATA		⇒ WHITE, GREY, USER1, USER2
	OTHERS	SCALE	⇒ NORMAL, DARK, USER1, USER2
		OS/TOOL	⇒ NORMAL, USER1, USER2
		TGT	⇒ NORMAL, USER1, USER2
		COAST LINE	⇒ NORMAL, USER1, USER2
		NAV LINE	⇒ NORMAL, USER1, USER2
		ROUTE	⇒ NORMAL, USER1, USER2
		EVENT MKR	⇒ NORMAL, USER1, USER2
		AREA	⇒ NORMAL, USER1, USER2
		PAST TRK	⇒ NORMAL, USER1, USER2
		MONITORED ROUTE	⇒ NORMAL, USER1, USER2
		LAT /LON LINE	⇒ NORMAL, USER1, USER2
	CURSOR	⇒ NORMAL, DARK, USER1, USER2	
	CHART LAND	⇒ BROWN, GREEN, LIME, YELLOW, USER1, USER2	
	DEPTH	⇒ WHITE, BLUE, USER1, USER2	

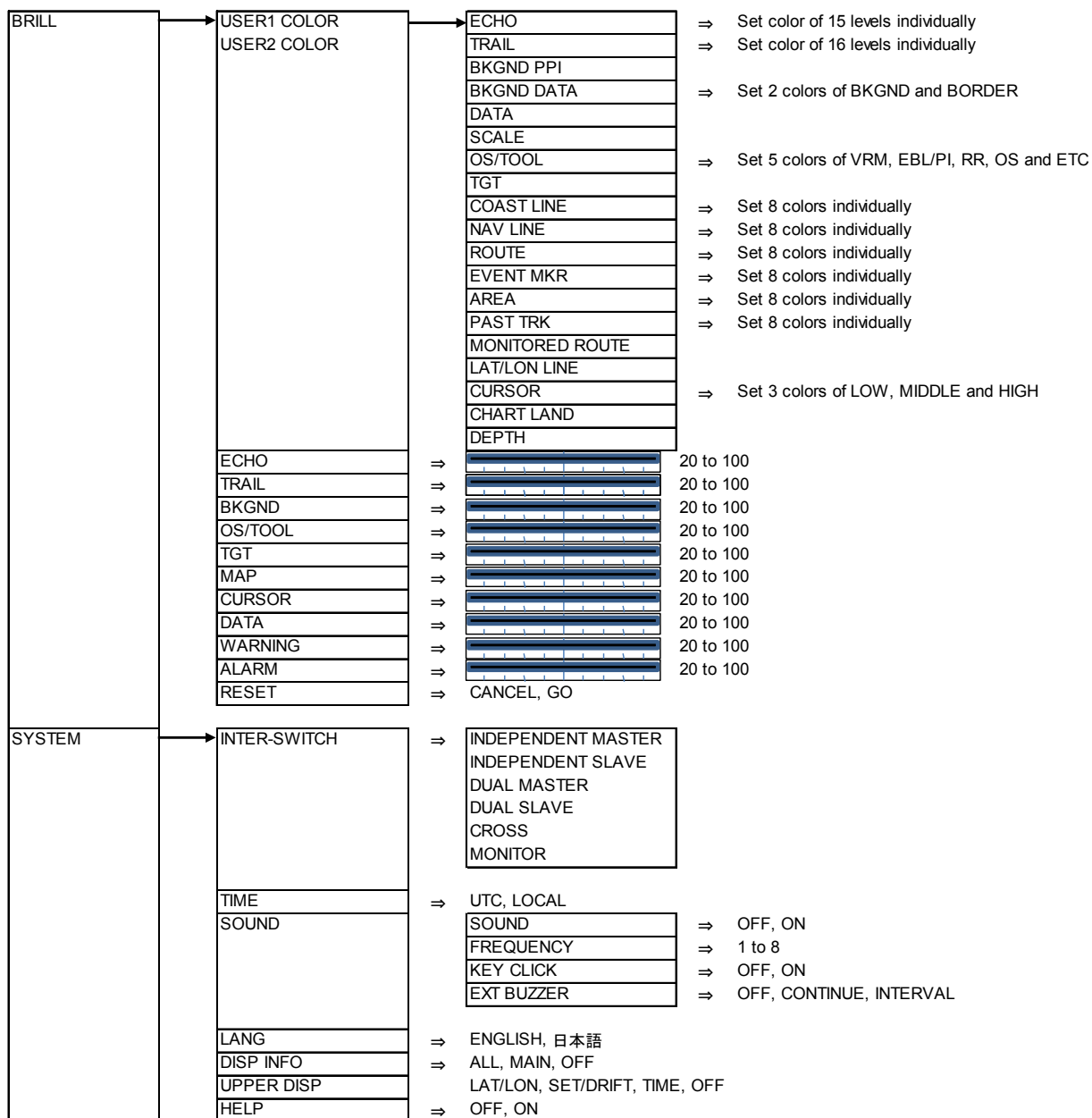

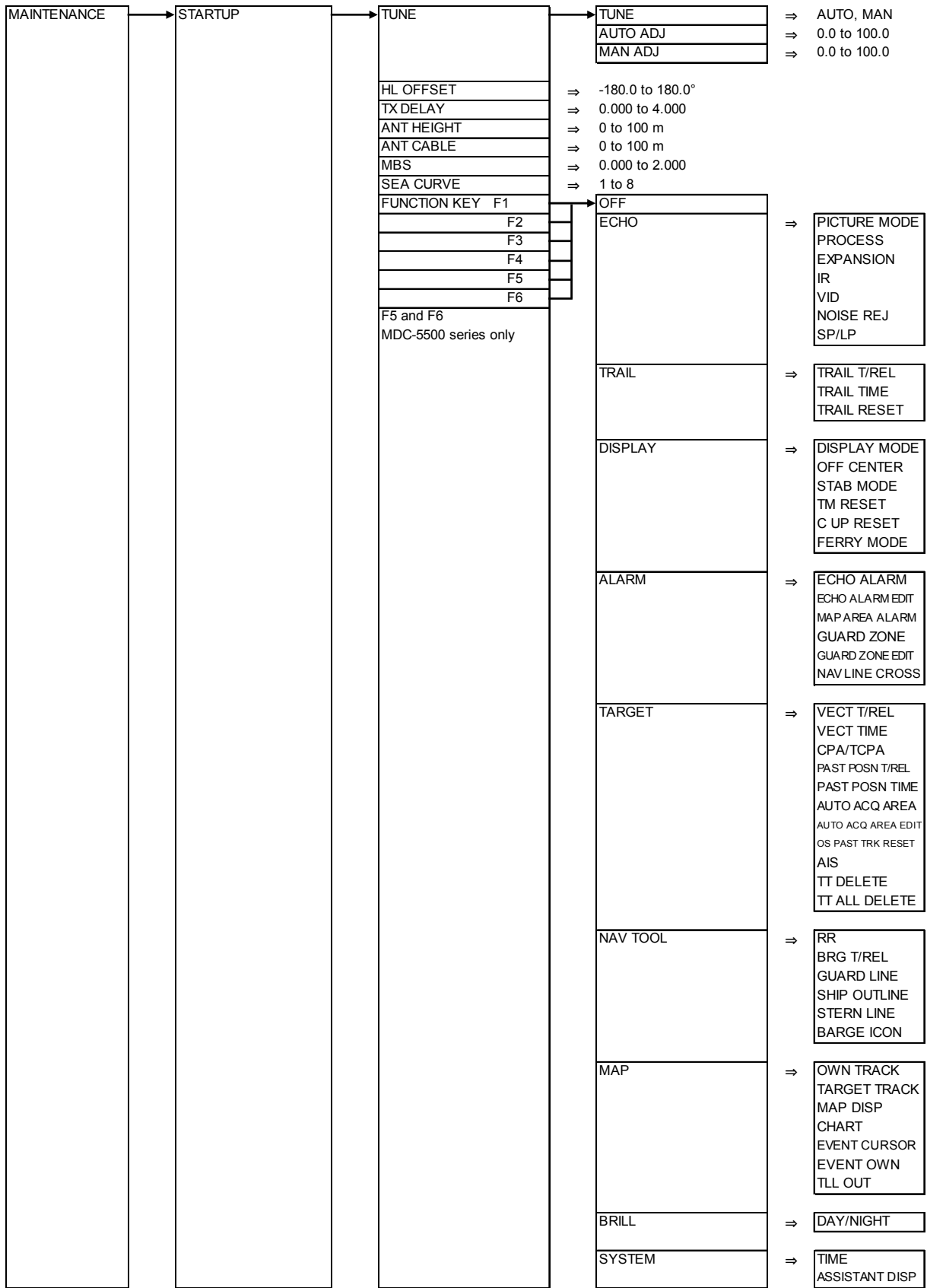

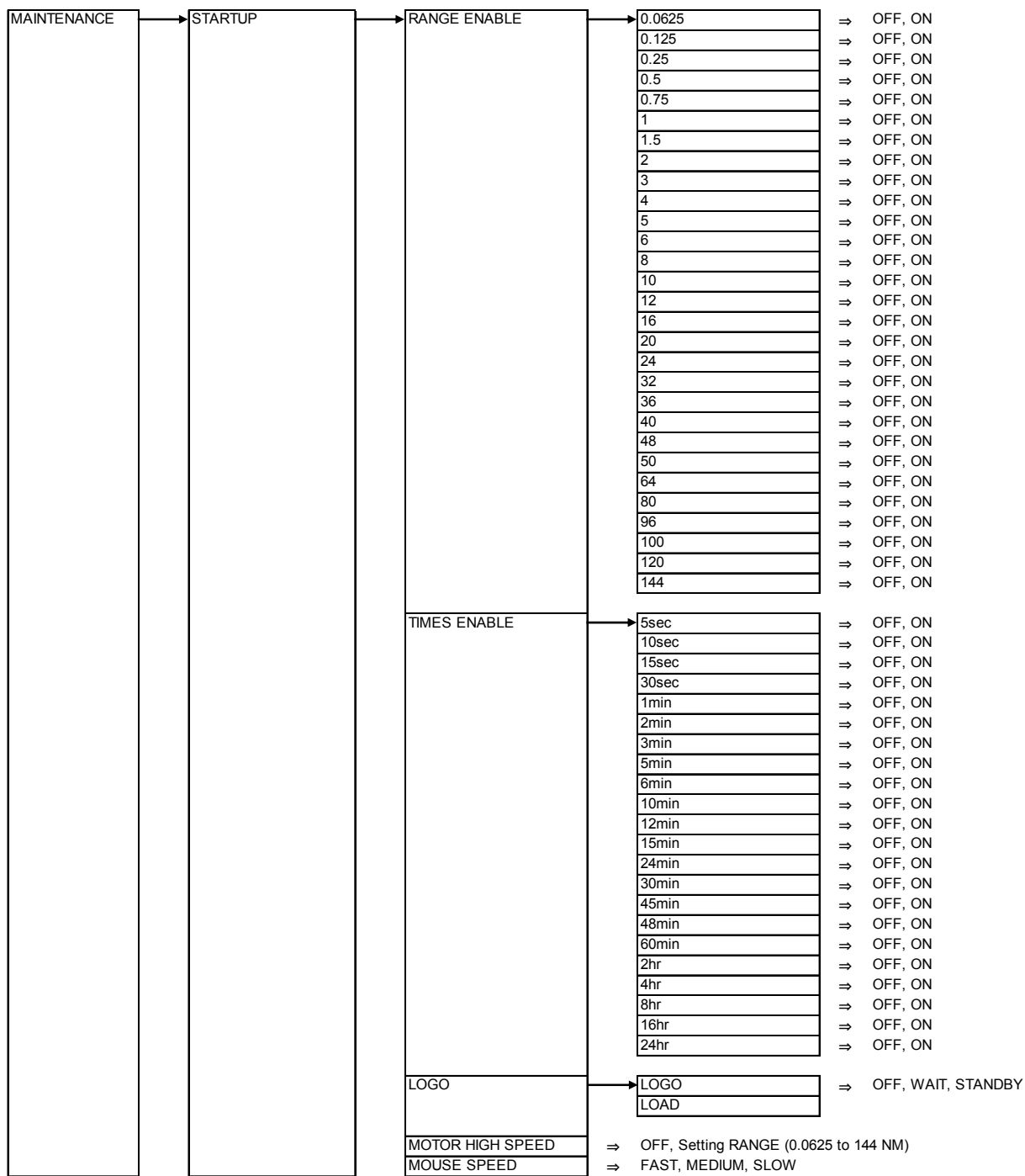

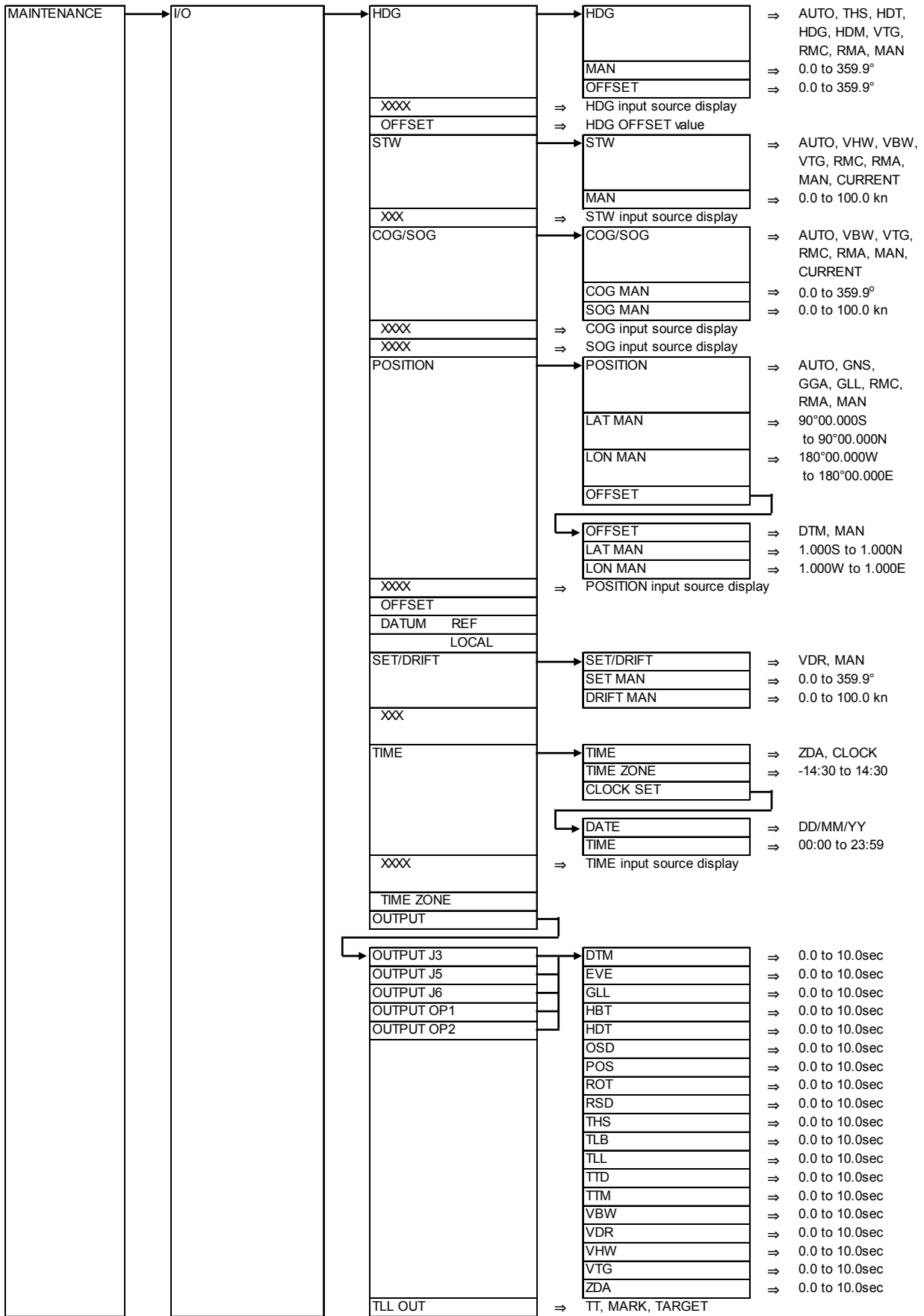

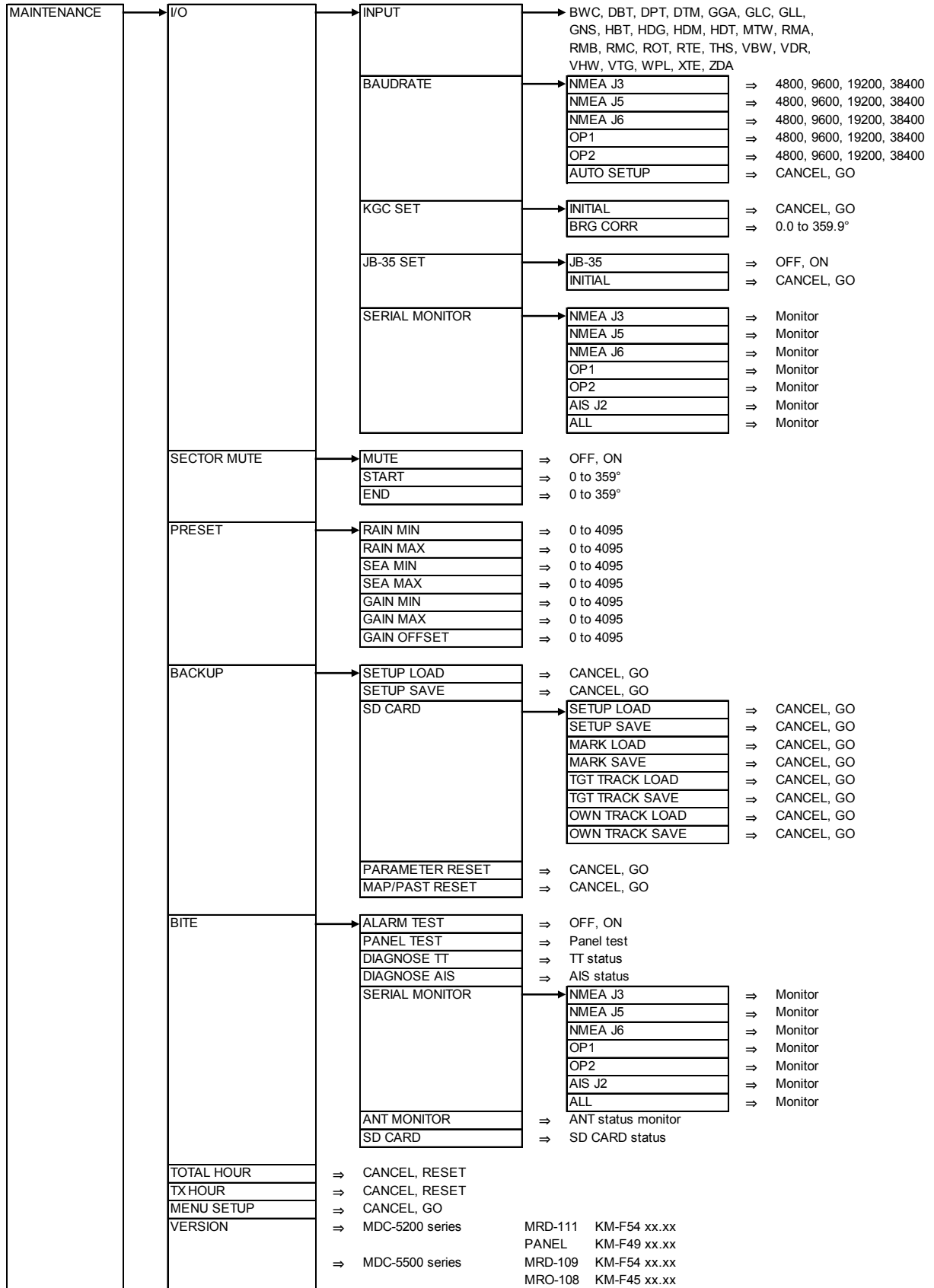

- This page intentionally left blank.-

Chapter 12 Index

A

ACTIVE/SLEEP	4-8
AIS	4-8
AIS FILTER	4-10
AIS ID DISP	4-3, 4-16
AIS target symbol.....	4-12
Alarm	3-1
ALL PPI.....	2-50
AREA	6-11
ASSISTANT INFO.....	2-51
ASSOCIATION.....	4-5
AtoN.....	4-10
AUTO ACQ AREA.....	4-6
AUTO GAIN	2-8
AUTO SEA.....	2-10
Automatic acquisition area.....	4-6

B

BACKUP	7-6
Barge icon.....	5-3
Bearing mode.....	2-25
Brightness	2-33
Brilliance	2-2

C

C UP	2-17
CFAR	2-13
COAST LINE.....	6-3
Course up	2-17
CPA/TCPA	4-3
CROSS	2-46
Cursor	2-47
Cursor data	2-47

D

DATUM	6-13
-------------	------

Day/Night.....	2-31
Delete all TT target	4-17
Delete TT target	4-17
Display Mode	2-16
DUAL MASTER	2-46
DUAL SLAVE	2-46

E

EBL.....	2-23
EBL OFFSET	2-24
Echo alarm.....	3-1
Echo color.....	2-31
Echo color rejection	2-43
Echo process	2-40
Electronic bearing lines.....	2-23
ERBL	2-28
EVENT MKR.....	6-10
Expansion	2-41
External buzzer.....	7-3
External save	7-7

F

Fault diagnosis.....	9-1
FERRY MODE	2-49
Function key	2-38, 6-10

G

GAIN	2-8
Ground stabilization	2-20
Guard line	5-1
Guard zone alarm	3-7

H

H UP	2-16
Head up	2-16
Heading line.....	2-34
HELP window	7-5

HL blink 5-2
 How to update 7-11

I

ID DISP SIZE 4-4
 INDEPENDENT MASTER 2-45
 INDEPENDENT SLAVE 2-45
 Input range 4-4
 INTER SWITCH 2-45
 Internal save 7-6
 Inter-switch 2-45
 IR 2-39, 2-42

L

LOST ALARM 4-3

M

MAINTENANCE 7-6
 MAN GAIN 2-8
 MAN SEA 2-10
 Manual acquisition 4-16
 Map area 3-3, 6-11
 MENU 1-8
 MMSI 4-9
 MONITOR 2-46
 MONITORED ROUTE 6-11

N

N UP 2-17
 NAV LINE 6-8
 Nav line cross 3-8
 Noise rejection 2-43
 North up 2-17

O

Off Center 2-37
 Off-centering 2-37
 Own ship outline 2-48
 OWN SHIP PAST TRACK 6-1

P

Panel brilliance 2-3
 Parallel Index (PI) lines 2-26
 Parameter reset 7-8
 Past position 4-7
 PAST POSN 4-7
 PATH PREDICTOR 4-2
 PI 2-26
 Picture mode 2-39
 POWER ON/OFF 2-1
 Process 2-40
 Pulse width 2-15, 2-44
 Pulse width (SP/LP) 2-15

R

RAIN 2-12
 RAIN MAN 2-14
 Rain/snow clutter 2-12
 Range 2-7
 Range Rings 2-21
 Range scale 2-7
 Range unit 2-7
 Relative display 2-36
 Relative motion 2-18
 reset 7-8
 Reset true motion 2-19
 ROTATION MARGIN 2-50
 ROTATION SPEED 2-51
 ROUTE 6-9
 RR 2-21

S

SEA 2-8, 2-10
 Sea clutter 2-8, 2-10
 Sea stabilization 2-20
 Ship outline 2-48
 Sleeping lost 4-3, 4-11
 STAB 2-20

STAB INDICATOR 4-2
STANDBY 2-1
Stern line 5-2

T

Target trail 2-34
TIME INCREMENT 4-1
TM reset 2-19, 2-51
TOTAL HOUR 7-9
Tracked target symbol 4-18
Trail 2-34
Transmission 2-4
True display 2-36
True motion 2-18
TT 4-15
TT ID DISP 4-4
Tuning method 2-5

Turn indicator 4-9
TX HOUR 7-9

U

User memory 7-2
UTC / LOCAL time 7-1

V

Variable Range Marker 2-22
VECTOR 4-1
VECTOR REL/TRU 4-1, 4-16
Video contrast 2-42
VRM 2-22

W

WAIT 2-1



Koden Electronics Co., Ltd.

Tamagawa Office:

2-13-24 Tamagawa, Ota-ku, Tokyo, 146-0095 Japan

Tel: +81-3-3756-6501 Fax: +81-3-3756-6509

Uenohara Office:

5278 Uenohara, Uenohara-shi, Yamanashi, 409-0112 Japan

Tel: +81-554-20-5860 Fax: +81-554-20-5875

www.koden-electronics.co.jp